

**BONALDO**  
LIGHTING COLLECTION



***BONALDO***



MADE IN ITALY

BONALDO Lighting Collection

Con la collezione di lampade, Bonaldo omaggia una delle forme più antiche e pregiate di artigianato italiano: la tradizione veneziana della lavorazione del vetro. Grazie all'estro dei designer e alla sapienza dei maestri vetrai si sviluppano sagome sottili ed evanescenti, striature e sfumature di colore: antichi segreti per nuove idee luminose.

*With its collection of lamps, Bonaldo pays tribute to one of the oldest and most prized forms of Italian craftsmanship: the Venetian tradition of glass-blowing. The flair of the designers is combined with the expertise of master glass blowers to develop subtle and evanescent shapes, stripes and various shades of colour: ancient secrets for new bright ideas.*





Nella collezione Bonaldo, il vetro soffiato diventa una forma pura e geometricamente essenziale che, insieme alla sapienza degli artisti che lo plasmano, racchiude e racconta la storia di un territorio ricco di suggestioni, poesia e antica cultura artigiana.

*In Bonaldo's lighting collection, blown glass becomes a pure and geometrically elemental form which, together with the expertise of the artists who ply it, encases and tells the tale of a land of charm, poetry and age-old craftsmanship culture.*

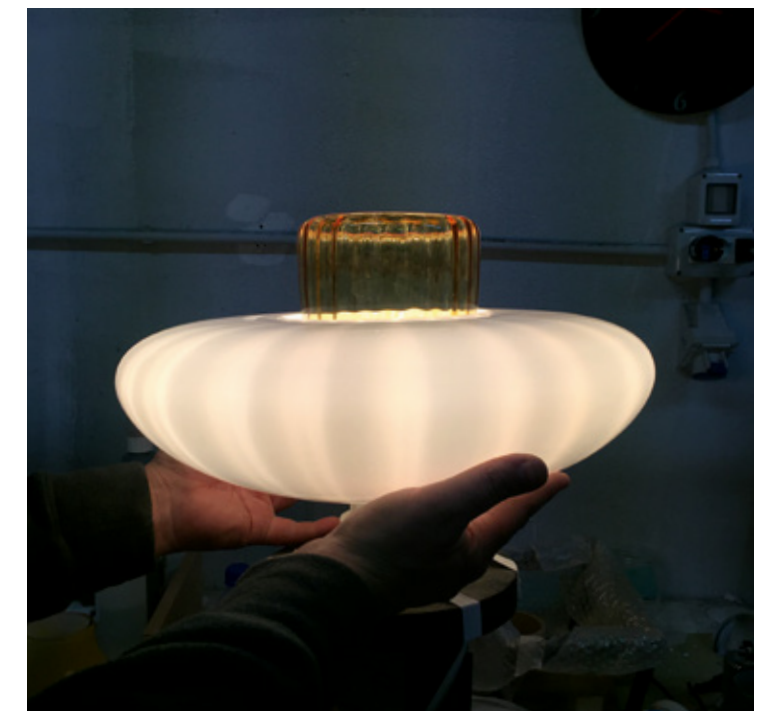

Estratto dai forni il vetro è massa incandescente che l'artigiano plasma soffiando e modellando con gli attrezzi dedicati. Malleabile e fluida, la materia viene sagomata a mano libera, con sapienza e tecnica millenaria per divenire seducente artefatto.

*When it comes out of the kilns, the glass is an incandescent mass which the craftsman plies by blowing and moulding into shape using dedicated tools. Malleable and fluid, the material is shaped freehand, with skill and a thousand-year-old technique, turning it into a seductive artefact.*







S



M

Il vetro borosilicato, grazie alle sue doti di leggerezza, precisione e trasparenza è utilizzato invece per la creazione di sistemi eterei, ricchi di forme ripetute, sospese come bolle di sapone. Esaltate dall'abbinamento tra vetro e metalli lavorati artigianalmente, le lampade Bonaldo rappresentano così un valore in sé, quello tangibile del Made in Italy.

*Borosilicate glass, whose many properties include lightness, precision and transparency, is used to create ethereal systems with repeated shapes, suspended like soap bubbles. Emphasised by the combination of glass and hand-crafted metals, Bonaldo lamps thus constitute value in themselves, tangible value of Made in Italy excellence.*

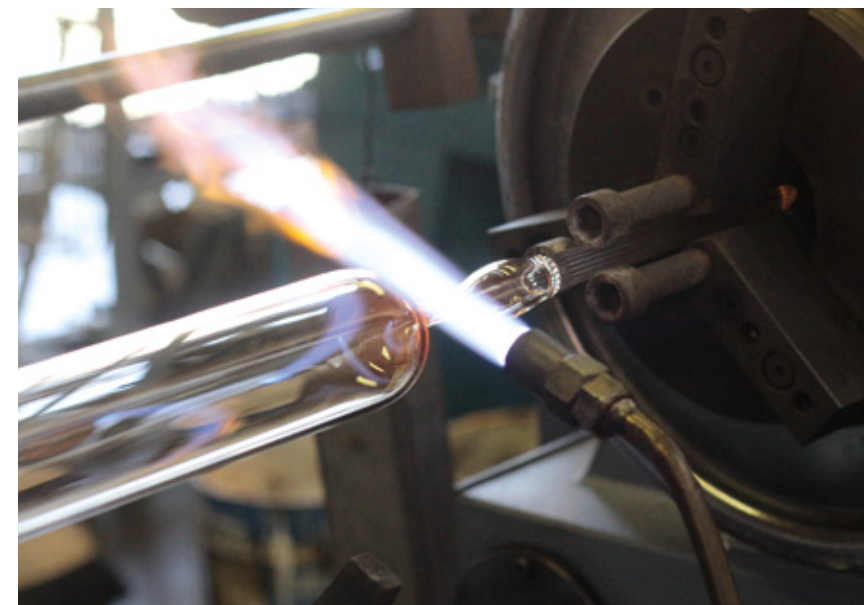



SOSPENSIONI / SUSPENSIONS

Acquerelli

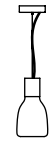

Acquerelli

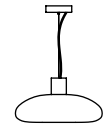

Acquerelli

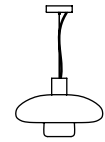

Acquerelli

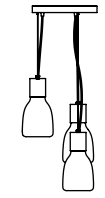

Crossroad

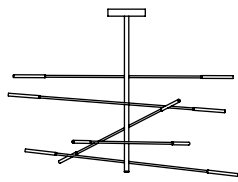

San / 3

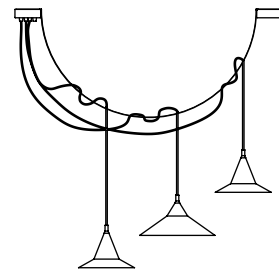

San / 4

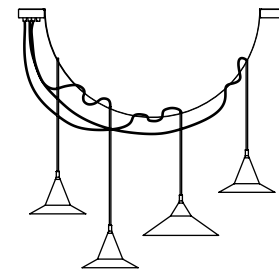

Sofi / 1



Sofi / 5

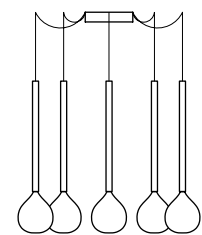

Sofi / 7

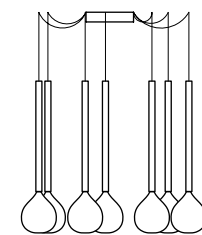

Sofi struttura 7 / structure 7

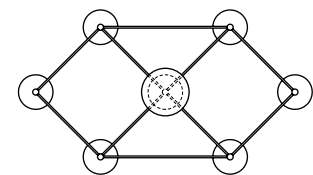
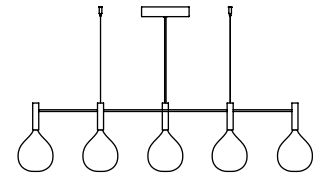

Sofi struttura 10 / structure 10

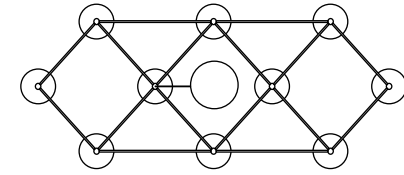
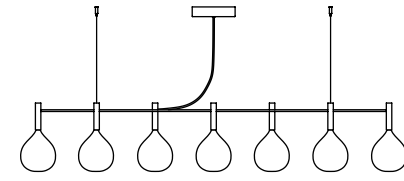

LAMPADE DA TAVOLO / TABLE LAMPS

Acquerelli



Acquerelli



Bardot

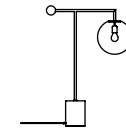

Sofi / 36



Sofi / 53



LAMPADE DA TERRA / FLOOR LAMPS

Bardot / 135

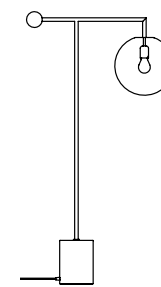

Bardot / 180

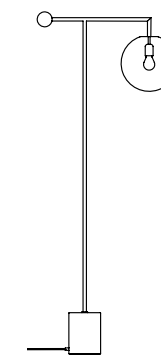

Crossroad

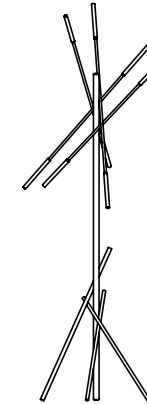

Sofi

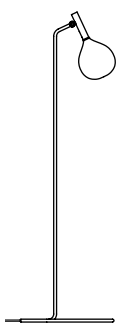

LAMPADE DA PARETE / WALL LAMPS

Sofi applique





S

## Sofi

Fin dal nome, Sofi è un omaggio all'antichissima e pregiata tecnica del vetro soffiato a mano. La sua forma primaria, la sfera in vetro borosilicato con una calda finitura ambrata, è abbinata a un cilindro in ottone brunito che contiene il corpo illuminante e riporta alla mente l'immagine dei mastri vetrai che, nei loro laboratori veneti, si servono delle lunghe canne da soffio per plasmare sapientemente la materia incandescente.

La collezione si declina in molteplici modelli: il lampadario con struttura metallica a 7 o 10 sfere, la sospensione composta da 1, 5 o 7 elementi, la lampada da terra, la lampada da tavolo in due versioni (più bassa e senza sfera in vetro, oppure più alta con sfera in vetro) e l'applique, contraddistinta dalla doppia direzione dell'emissione luminosa.

*From its very name, Sofi pays homage to the age-old and prized hand glass-blowing technique. Its primary shape, the borosilicate glass globe with a warm amber finish, is combined with a burnished brass cylinder which contains the light source and brings to mind the image of master glass-blowers who, in their Venetian workshops, use their long blowpipes to craft the incandescent molten glass with skill.*

*The collection consists of multiple models: the ceiling lamp with a metal frame with 7 or 10 globes, the suspension with 1, 5 or 7 globes, the floor lamp, two versions of the table lamp (lower without a glass globe and higher with a glass globe) and the wall lamp, distinguished by the double direction of the light flux.*



O







SOFÌ struttura 7 / structure 7

 struttura frame		220-230 V 110 V	Led Spot	3 W (30 W)	2.700 °K	357 lm	80 CRI	A++
--	---	--------------------	----------	------------	----------	--------	--------	-----

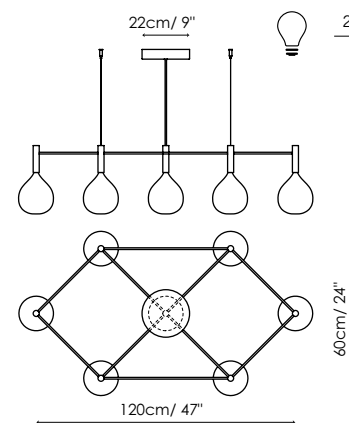



SOFI lampada/lamp  
design Studio Team Design



p. 12 / 13





SOFì lampada/lamp  
design Studio Team Design



SOFì struttura 10 / structure 10

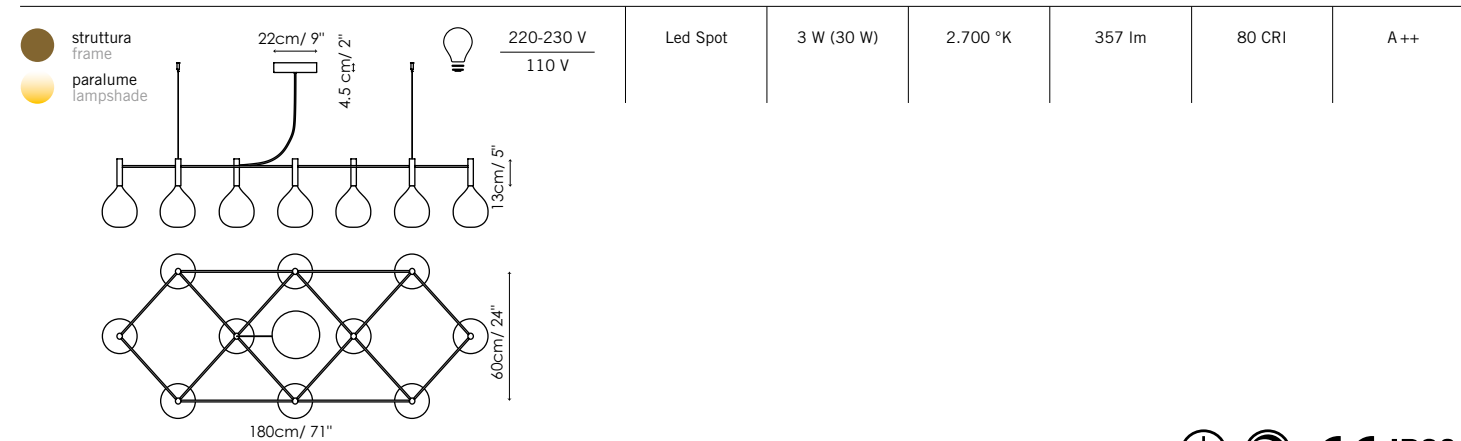



SOFI sospensione I / suspension I

- struttura  
frame
- paralume  
lampshade

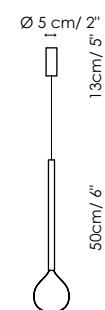

	220-230 V 110 V	Led Spot	3 W (30 W)	2.700 °K	357 lm	80 CRI	A++
---	--------------------	----------	------------	----------	--------	--------	-----





SOFI lampada/lamp  
design Studio Team Design



p. 18 / 19





SOFÌ lampada/lamp  
design Studio Team Design

SOFÌ sospensione 5 / suspension 5

- struttura  
frame
- paralume  
lampshade

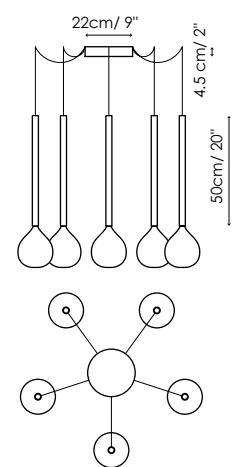

220-230 V  
110 V

Led Spot

3 W (30 W)

2.700 °K

357 lm

80 CRI

A++

CLASSE 1 / CLASS 1





CE IP20





SOFì lampada/lamp  
design Studio Team Design

SOFì sospensione 7 / suspension 7

 struttura frame		220-230 V 110 V	Led Spot	3 W (30 W)	2.700 °K	357 lm	80 CRI	A++
--	---	--------------------	----------	------------	----------	--------	--------	-----

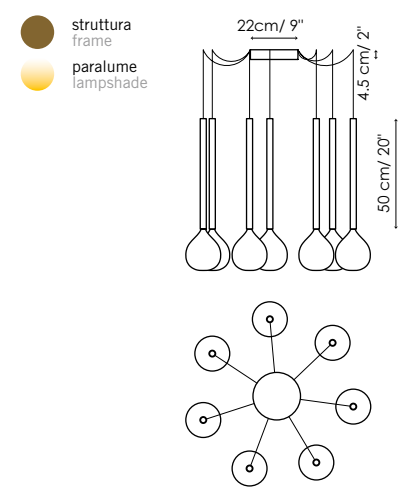



CLASSE 1 / CLASS 1   CE IP20



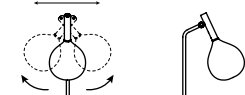
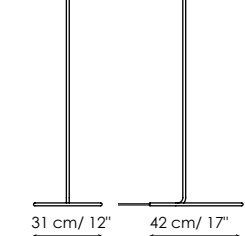

SOFÌ lampada da terra / floor lamp

 struttura frame	39 cm / 15"		220-230 V 110 V	Led Spot	3 W (30 W)	2.700 °K	357 lm	80 CRI	A++
 paralume lampshade									
									









SOFI lampada/lamp  
design Studio Team Design



SOFI lampada da tavolo / table lamp

● struttura frame			220-230 V 110 V	Led Spot	3 W (30 W)	2.700 °K	357 lm	80 CRI	A++
● struttura frame									
● paralume lampshade									

CLASSE 2 / CLASS 2 CE IP20





SOFÌ da parete / wall lamp

● struttura frame			220-230 V 110 V	Led Spot	3 W (30 W)	2.700 °K	357 lm	80 CRI	A++
● paralume lampshade									



A

B

## Bardot

Elementi sferici si accostano a linee squadrate per comporre Bardot, la lampada che, come l'iconica attrice che il nome rievoca, si fa simbolo di una bellezza senza tempo grazie ai propri eleganti geometrismi.

La lampada, con paralume in vetro trasparente, è esaltata dalla base e da una sfera in ottone opaco e si contraddistingue per lo stelo personalizzabile, disponibile in diverse colorazioni, nelle versioni da tavolo o da terra.

*Spherical elements paired with squared silhouettes to bring together Bardot, the lamp which - like the namesake actress - symbolises timeless beauty thanks to its elegant geometric structure.*

*The lamp, with its transparent glass lampshade, is enhanced by the base and by a matt brass globe, and it stands out for the customisable rod, available in various colours, in the table or floor versions.*

D

R

















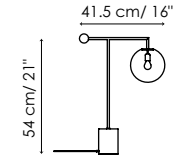



BARDOT lampada/lamp  
design Laura Cazzaniga e Ilaria Limonta

BARDOT da tavolo / table lamp

 struttura frame	 41.5 cm / 16"	 220-230 V 110 V	G9	3 W (20 W)	2.700 °K	300 lm	80 CRI	A+
 base e sfera base and sphere								
 paralume lampshade	54 cm / 21"							

CLASSE 1 / CLASS 1   IP20

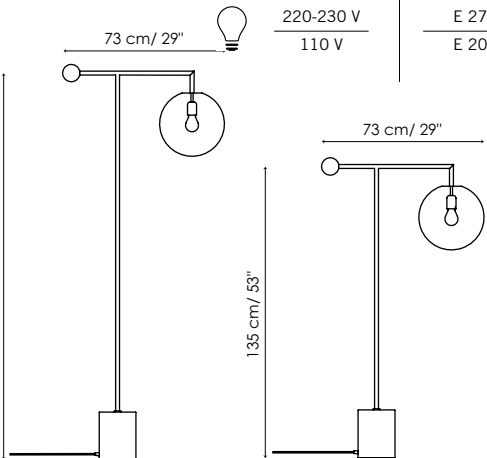
BARDOT da terra / floor lamp

 struttura frame	 73 cm / 29"	 220-230 V 110 V	E 27 E 20	12 W (100 W)	2.700 °K	1520 lm	80 CRI	A++
 base e sfera base and sphere								
 paralume lampshade	180 cm / 71"							
	135 cm / 53"							

CLASSE 1 / CLASS 1    IP20





## Crossroad

Crossroad è un progetto scultoreo, improntato a un segno estremo che si inserisce nello spazio con forte dinamismo. Il suo elemento base è un cilindro in metallo verniciato opaco color piombo che, alle due estremità, racchiude la fonte luminosa all'interno di un semplice eppure sofisticato elemento in vetro ambrato.

Il gioco della luce con il vetro e l'incrociarsi dei bracci in molteplici direzioni rende Crossroad, nella sua versione a sospensione o da terra, una lampada in grado di caratterizzare gli ambienti con un rilevante impatto scenografico.

*Crossroad is a sculptural design, marked by an extreme feature that leaves a strongly dynamic mark in a setting. Its basic element is a matt lead-colour painted metal cylinder which, at either extremities, encloses the light source inside a simple yet sophisticated amber-coloured glass element.*

*The game played between the light and the glass, along with the criss-crossing arms in a multitude of directions, makes Crossroad, in both the suspension and the floor version, a lamp capable of distinguishing settings with a remarkable scenic impact.*















CROSSROAD sospensione / suspension

<ul style="list-style-type: none"> <li><span style="display: inline-block; width: 10px; height: 10px; background-color: black; border-radius: 50%; margin-right: 5px;"></span> struttura frame</li> <li><span style="display: inline-block; width: 10px; height: 10px; background-color: yellow; border-radius: 50%; margin-right: 5px;"></span> paralume lampshade</li> </ul>			220-230 V 110 V	G 4	1.8 W (19 W)	2.700 °K	200 lm	80 CRI	A++
			220-230 V 110 V	Led Spot	3 W (30 W)	2.700 °K	357 lm	80 CRI	A++



CROSSROAD lampada/lamp  
design Oriano Favaretto



CROSSROAD da terra / floor lamp

● struttura frame	💡 220-230 V 110 V	G 4	1.8 W (19 W)	2.700 °K	200 lm	80 CRI	A++
----------------------	----------------------	-----	--------------	----------	--------	--------	-----

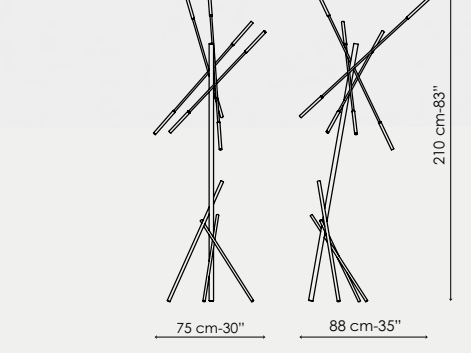

CLASSE 1 / CLASS 1   **CE IP20**





## Acquerelli

Colori delicati che esaltano le lavorazioni artigianali del vetro soffiato e che, come pennellate sovrapposte, si compongono tra loro e dialogano con l'ambiente circostante: la collezione Acquerelli si declina in modelli da tavolo e a sospensione caratterizzati dalla combinazione di paralumi in vetro e struttura in metallo verniciato opaco color piombo. I vetri sono disponibili nella finitura bianco latte oppure, in versione sfumato o rigato, nelle eleganti colorazioni petrolio o ambra.

Le lampade Acquerelli sono in due dimensioni, piccola o grande. Nella versione da tavolo alle due grandezze corrispondono due diverse forme di paralume. Nella versione a sospensione è disponibile anche l'opzione del vetro doppio, in cui il paralume piccolo e quello grande si combinano in un unico lampadario per creare sorprendenti giochi di luce.

*Delicate colours that enhance the hand-crafted workmanship of blown glass and which come together like overlapping brush-strokes, liaising with their surroundings: the Acquerelli collection consists of table lamp models and suspensions distinguished by the combination of glass lampshades and a matt lead-colour painted metal frame. The glass is available in milk white finish or, in the nuanced or striped version, in elegant petroleum or amber colour.*

*The Acquerelli lamps come in two sizes, large or small. In the table version, the two sizes correspond to two different lampshade shapes. In the suspension version, the double glass option is also available, with the small lampshade combined with the large one to create a single ceiling lamp to generate surprising games of light.*

















ACQUERELLI lampada/lamp  
design Marco Zito

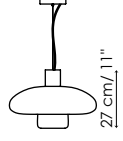
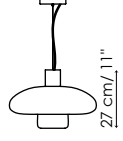
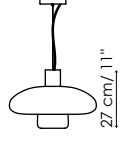
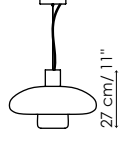

ACQUERELLI sospensione / suspension

<ul style="list-style-type: none"> <li> struttura frame</li> <li> paralume lampshade</li> <li></li> <li></li> <li></li> <li></li> </ul>				220-230 V 110 V	E 27 E 20	13 W (100 W)	2.700 °K	1520 lm	80 CRI	A++	
				220-230 V 110 V	E 27 E 20	12 W (100 W)	2.700 °K	1521 lm	80 CRI	A++	
											
											







ACQUERELLI lampada/lamp  
design Marco Zito





ACQUERELLI da tavolo / table lamp

● struttura frame	14,5 cm / 6"	 <table border="1"> <tr> <td>220-230 V</td> <td>E 14</td> <td>5 W (40 W)</td> <td>2.700 °K</td> <td>470 lm</td> <td>80 CRI</td> <td>A+</td> </tr> <tr> <td>110 V</td> <td>E 12</td> <td></td> <td></td> <td></td> <td></td> <td></td> </tr> </table>	220-230 V	E 14	5 W (40 W)	2.700 °K	470 lm	80 CRI	A+	110 V	E 12					
220-230 V	E 14		5 W (40 W)	2.700 °K	470 lm	80 CRI	A+									
110 V	E 12															
○ paralume lampshade	27 cm / 11"															
●	40 cm / 16"															
●	17 cm / 7"															
●																
●																





SAN lampada/lamp  
design Silvia Braconi

A

S

## San

L'ispirazione della lampada a sospensione San è orientale: la forma è un omaggio ai tipici copricapi dei paesi asiatici e il nome proviene da una parola cinese che ha una duplice valenza, in quanto significa ombrello (sǎn) ed è al tempo stesso un suffisso usato come vezzeggiativo o come titolo onorifico tra persone di ogni età e ceto sociale (san).

I paralumi, in metallo verniciato soft touch opaco sono disponibili in bianco o grigio. Il rosone e il supporto curvato, che permette il passaggio del cavo elettrico e la personalizzazione delle altezze delle lampade, sono invece in metallo verniciato opaco beige perlato. La sospensione è disponibile con 3 o 4 paralumi.

*The San suspension lamp draws its inspiration from the Orient: its shape pays a tribute to the typical headgear worn in Asian countries and the name comes from a Chinese word with a dual meaning, since it means umbrella (sǎn) and is at the same time a suffix used as an endearment or as an honorific title between people of all ages and social standing (san).*

*The lampshades, in matt soft touch painted metal, are available in grey or white. The ceiling rose and the curved support, through which the electrical cable runs and which can be used to customise the height of the lamps, are in matt pearl beige painted metal. The suspension is available with 3 or 4 lampshades.*

N

p. 58 / 59

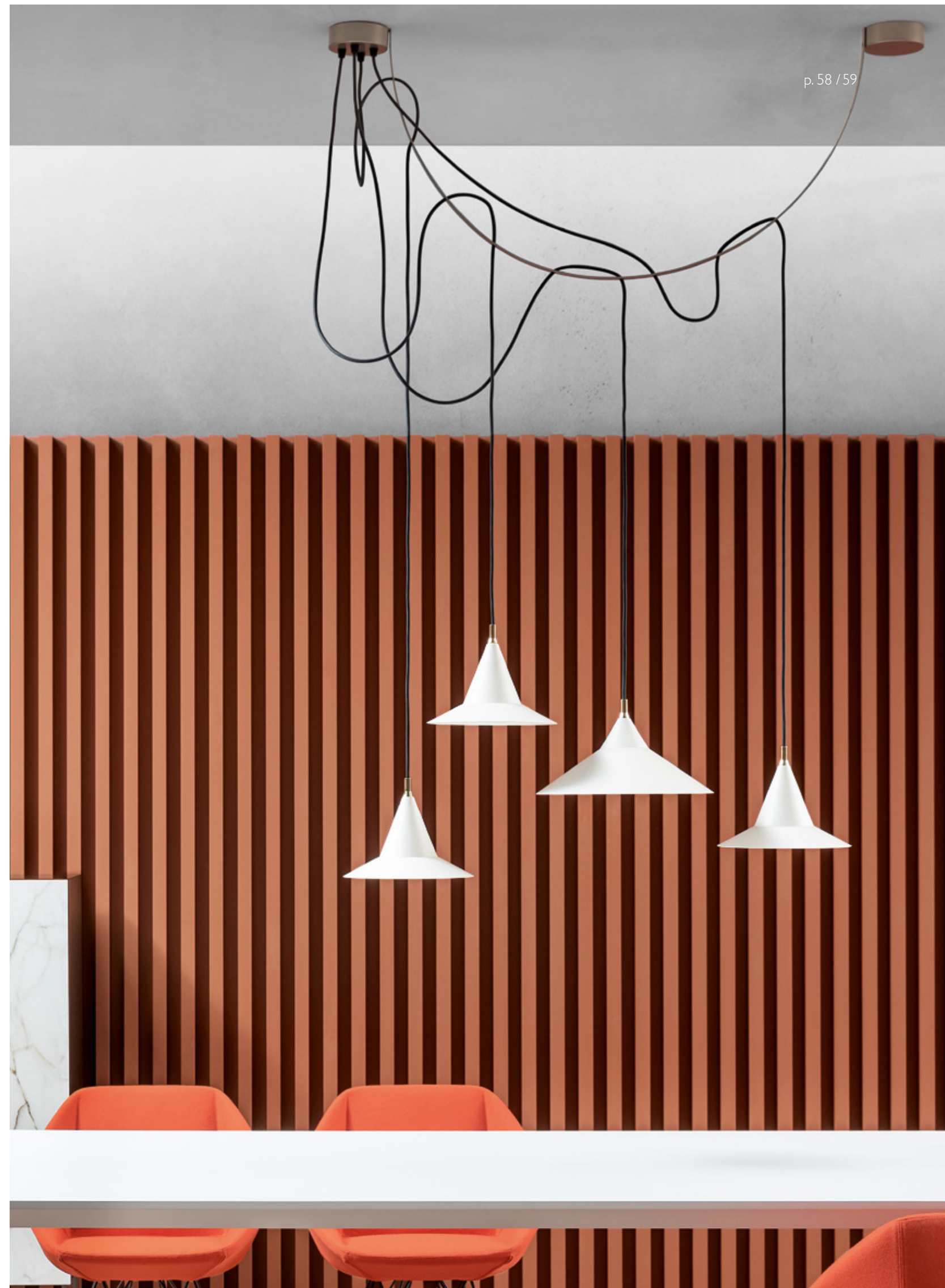











SAN lampada/lamp  
design Silvia Braconi



SAN sospensione / suspension

-  struttura  
frame
-  paralume  
lampshade
- 

	220-230 V 110 V	E 27 E 20	7.5 W (60 W)	2.700 °K	806 lm	80 CRI	A++
---	--------------------	--------------	--------------	----------	--------	--------	-----

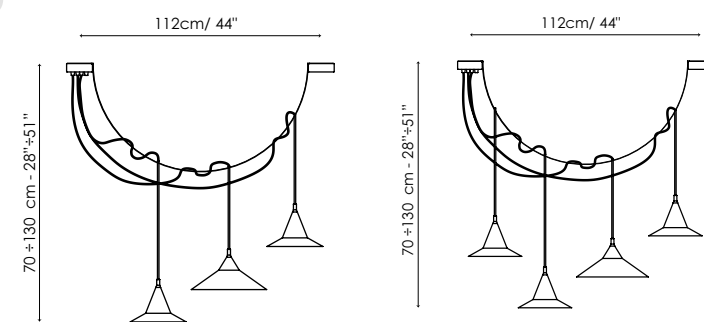

CLASSE 1 / CLASS 1   CE IP20



**concept**

romanoassociati.com

**styling**

Candida Zanelli

**assistant**

Serenella Parri

**photographer**

Beatrice Favaretto

Beppe Brancato

BTM

Marco Zito

Paolo Golumelli

**post-production**

Mediumgray

**printing**

Grafiche Antiga

**printed in Italy**

September 2019

**thanks to:**

CC Tapis

ph. Enza Tamborra

Fritz Hansen

Henry Timi

Mason Editions

ph. Matteo Cirenei

Osborne&Little

Paola C

Salvatori

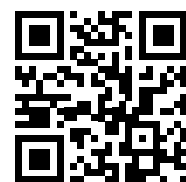

Bonaldo SpA si riserva il diritto di modificare, senza preavviso, materiali, rivestimenti, finiture e disegni dei prodotti presentati in questo catalogo.

I colori e le finiture visualizzate sono puramente indicativi e possono differire dagli originali.

Le immagini riprodotte nel presente catalogo sono di proprietà esclusiva di Bonaldo SpA.

È vietata qualunque riproduzione o utilizzo delle immagini senza preventiva autorizzazione scritta di Bonaldo SpA.

Bonaldo SpA reserves the right to change, without any notice, materials, covers, finishes and drawings of the products presented in this catalogue.

Colors and finishes shown are approximate and may differ from actual ones.

All images in this catalogue are exclusive property of Bonaldo SpA.

Every reproduction or use of the images without prior written authorization from Bonaldo SpA is therefore strictly forbidden.



# **BONALDO**

Bonaldo SpA\_via Straelle, 3\_35010 Villanova di Camposampiero (PD) Italy  
tel + 39 049.9299.01 | [bonaldo@bonaldo.it](mailto:bonaldo@bonaldo.it) [www.bonaldo.it](http://www.bonaldo.it)

