



Cloud 7

Produktdaten

Product information
Information produits

Bretz
True Characters



Außen Dynamik, innen Stille



F 154 Cloud 7 ▶ 252 cm ▼ 134 cm ▲ 78 cm
Stoff · Fabric · Tissu **64 2960**

Urbane Imposanz versus Retro-Futuristik – Cloud 7 spielt mit Spannungen: Die Rautenstruktur kommt vollständig ohne 90°-Winkel aus. So entsteht die surreale, einladende Illusion eines Fluchtpunkts. Gleichzeitig verpasst die Geometrie der voluminösen Silhouette eine gute Portion Dynamik. Mit der durchdachten Kassettenheftung schafft Cloud 7 ein einzigartiges Gefühl von Ruhe: Man sitzt darauf und gleichzeitig mittendrin.



Z 164 Cloud 7 ▶ 318 cm ▼ 318 cm ▲ 78 cm
Stoff · Fabric · Tissu **66 2085**

Dynamic on the outside, silent on the inside

Urban impressiveness versus retro futurism – Cloud 7 plays with tensions: The diamond shaped structure gets by without a 90° angle. Which is how this surreal, inviting illusion of a vanishing point is created. At the same time, geometry lends a dynamic attitude to the voluminous silhouette. The well thought-out cassette stitching gives Cloud 7 a unique feeling of peace: One sits on it while being right in the middle of it.



B 122 Hangout ▶ 87 cm ▼ 114–129 cm ▲ 115 cm
Stoff · Fabric · Tissu **66 2085**

C 122 Hangout ▶ 84 cm ▼ 63 cm ▲ 44 cm
Stoff · Fabric · Tissu **66 2085**

Collection **Ocean 7**

Le style urbain imposant face au style rétro-futuriste ; Cloud 7 joue avec les tensions. La structure en losanges ne présente aucun angle droit. Cela crée une illusion surréaliste et envoûtante d'un point de fuite. En même temps, la géométrie de la silhouette volumineuse confère un dynamisme puissant. La formation des cassettes du Cloud 7 offre une sensation de calme exceptionnelle. On s'assoit dessus et dedans en même temps.



G 154 Cloud 7 ▶ 259 cm ▼ 177 cm ▲ 78 cm
Stoff · Fabric · Tissu **65 BOH67**

Facts & Highlights

- Cloud 7 ist der ultimative Bretz-Klassiker
- Kassettenheftung in höchster Manufaktur-Qualität
- Baukastensystem mit zwei Sitztiefen für mehr Individualität
- Sooooo bequem
- Kein 90° Winkel
- Unkonventionelle Grundrisse

- Cloud 7 is the epitome of the Bretz philosophy
- Premium, artisan-quality cassette upholstery
- Modular system with two seat depths
- Comfort that's out of this world
- Not a single right angle
- Truly unconventional layout

- Cloud 7 est le classique Bretz par excellence
- Capitonnage à cassettes de la meilleure qualité artisanale
- Système modulaire avec deux profondeurs d'assise
- Tellement confortaaaaable
- Pas d'angle à 90 degrés
- Structures non-conventionnelles



B 122 Hangout ▶ 87 cm ▼ 114-129 cm ▲ 116 cm
Stoff · Fabric · Tissu **65 BOH67**

C 122 Hangout ▶ 84 cm ▼ 63 cm ▲ 44 cm
Stoff · Fabric · Tissu **65 BOH67**

**Dynamisme
extérieur, calme
intérieur**



H 154 Cloud 7 ▶ 94 cm ▼ 200 cm ▲ 93 cm
Stoff · Fabric · Tissu **70 4042**



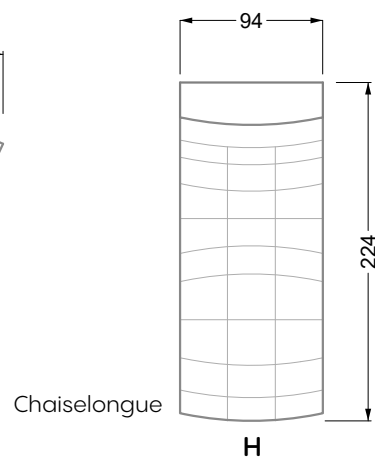
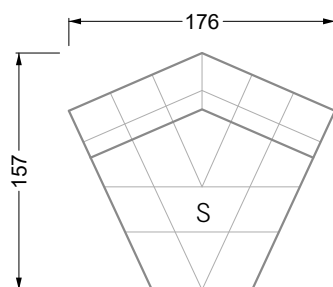
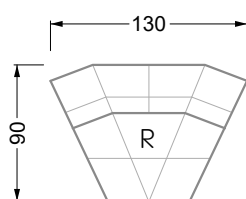
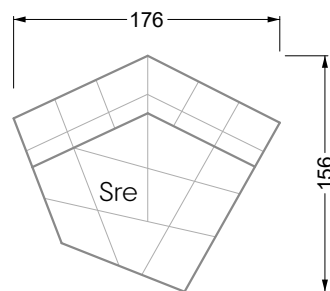
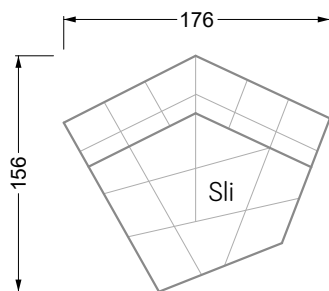
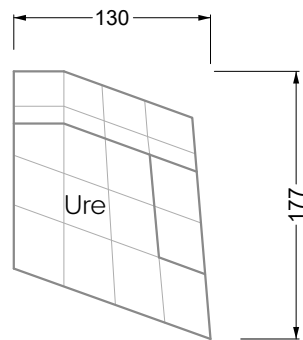
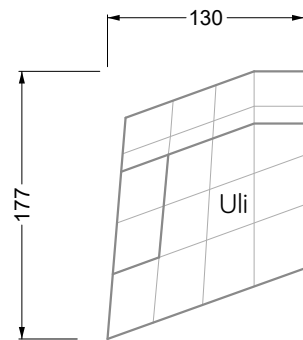
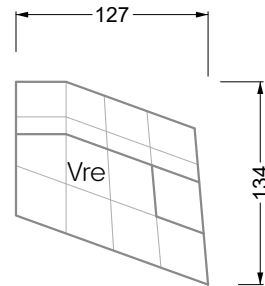
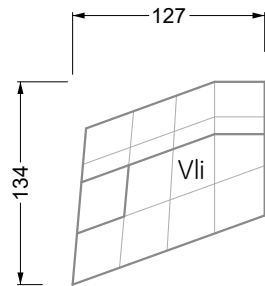
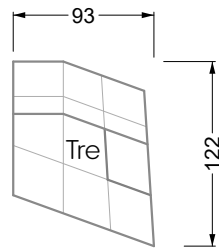
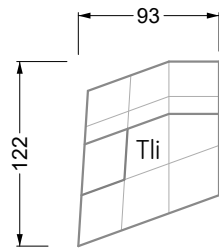

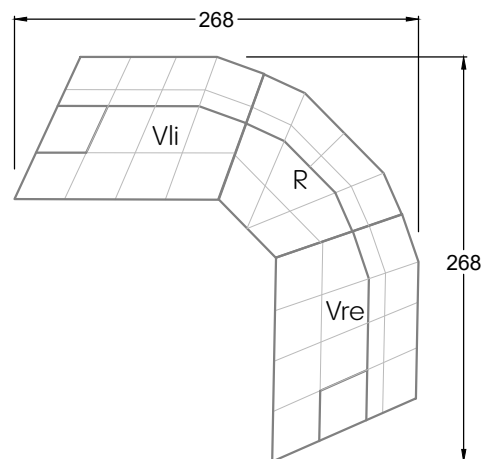
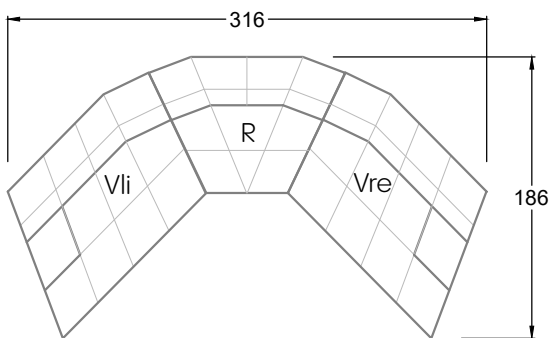
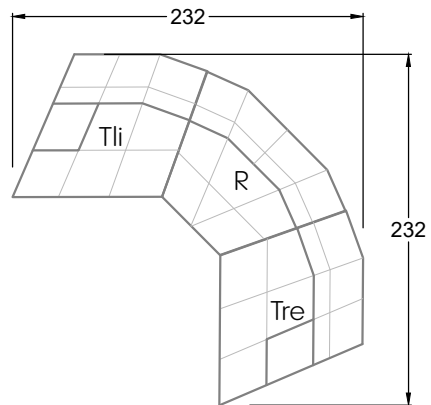
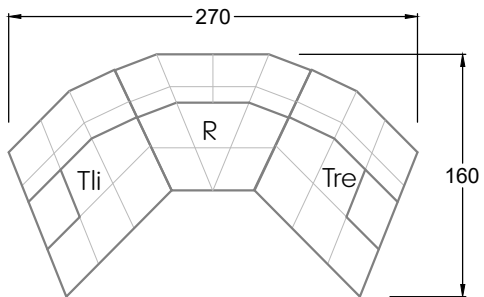
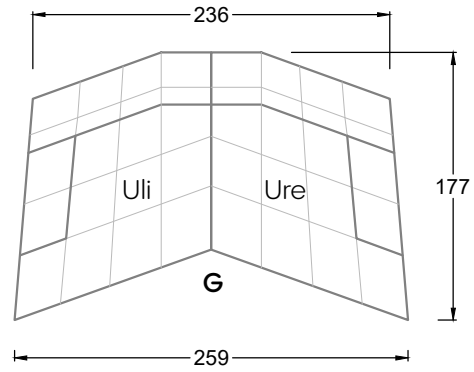
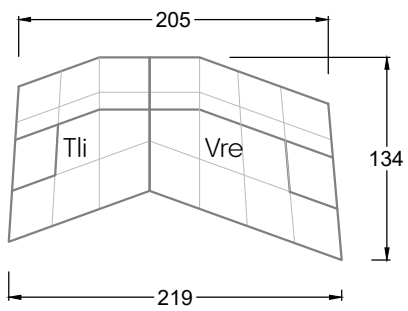
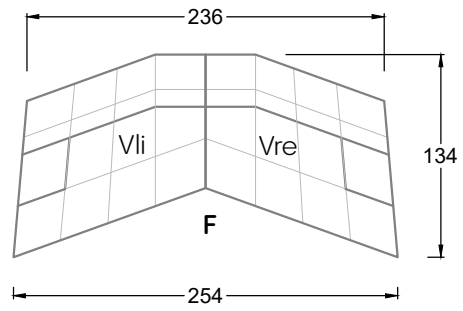
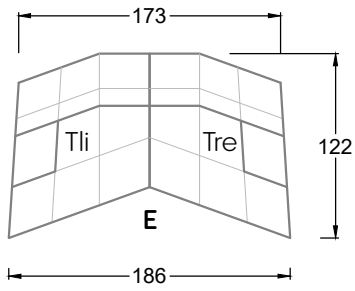

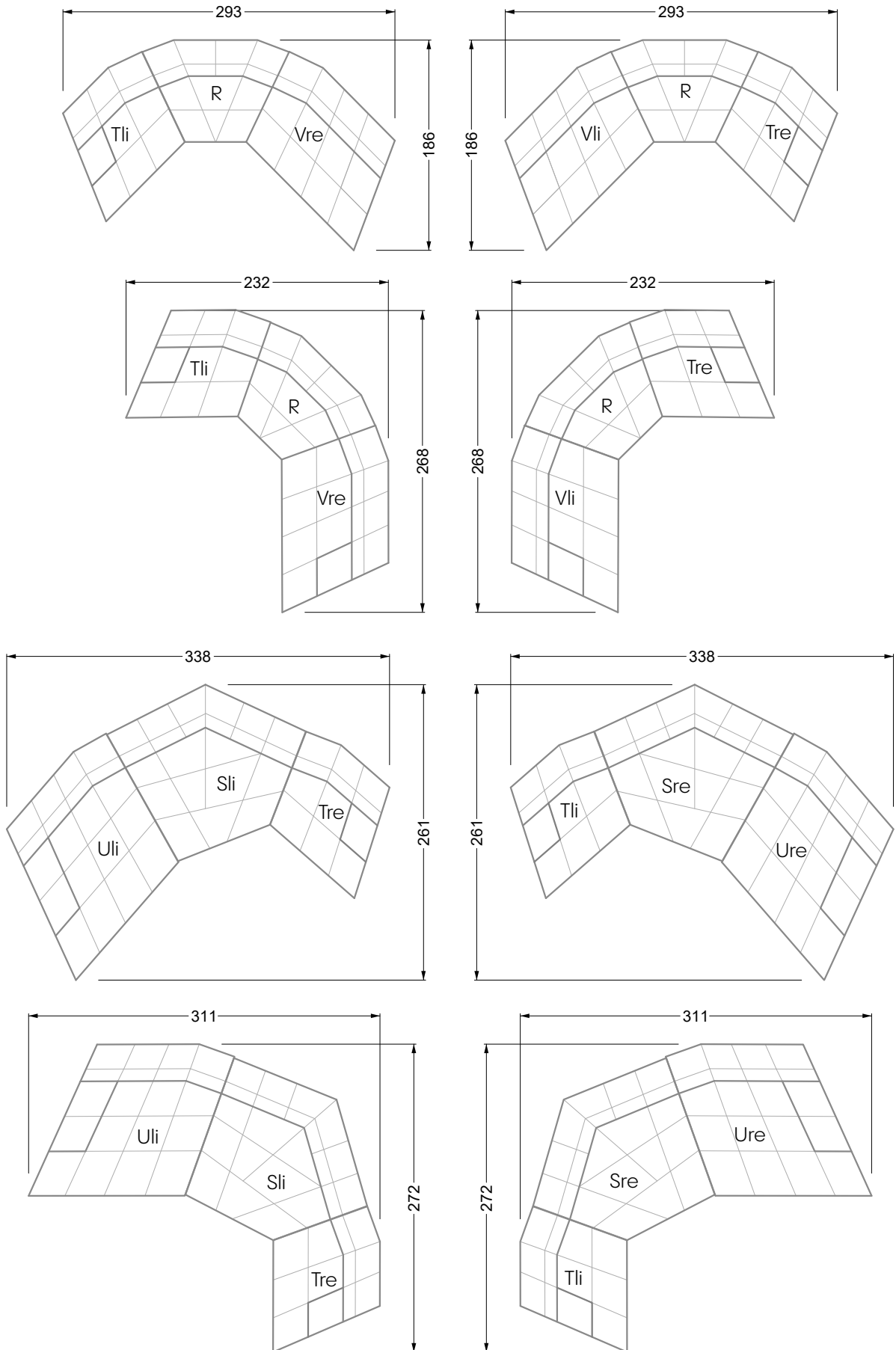

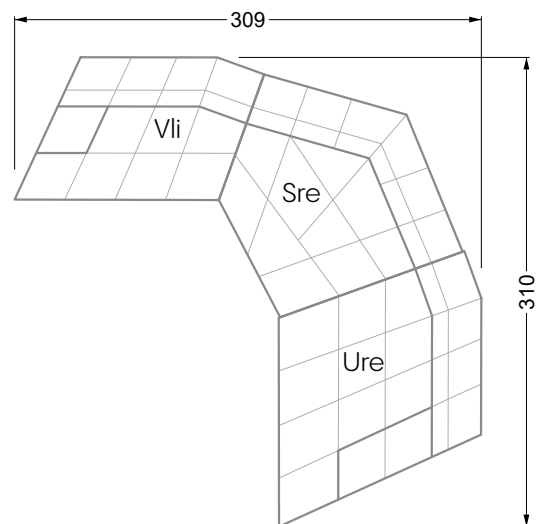
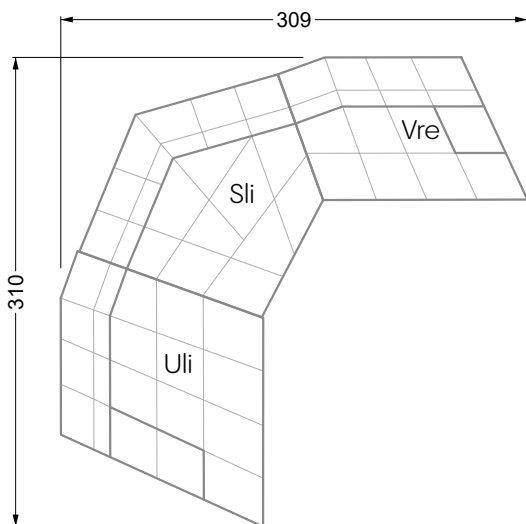
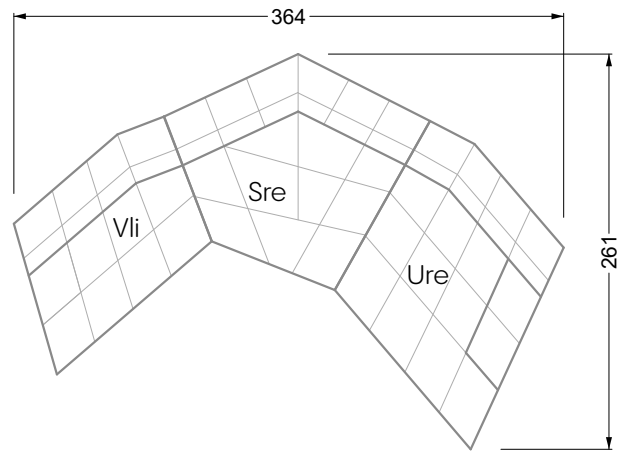
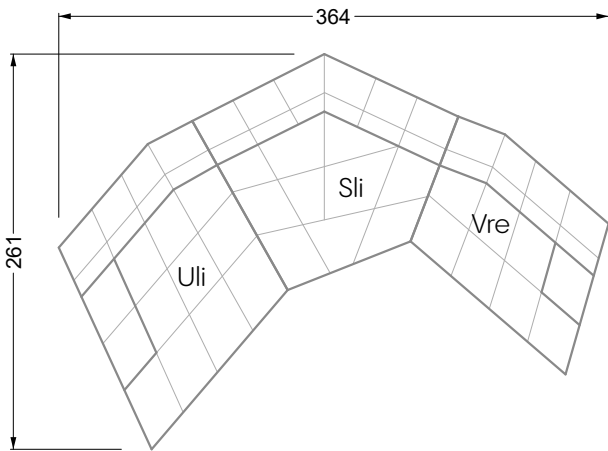
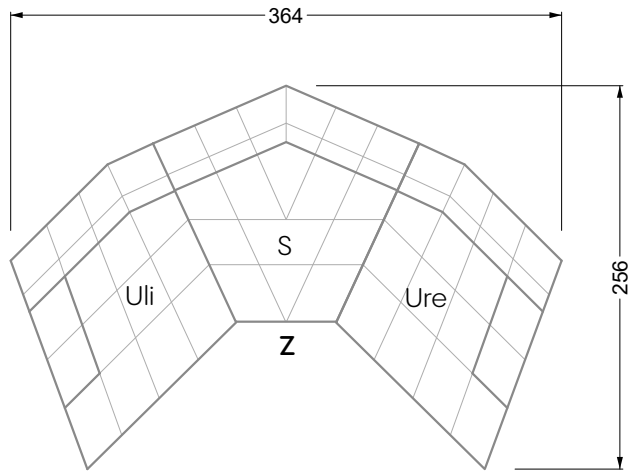
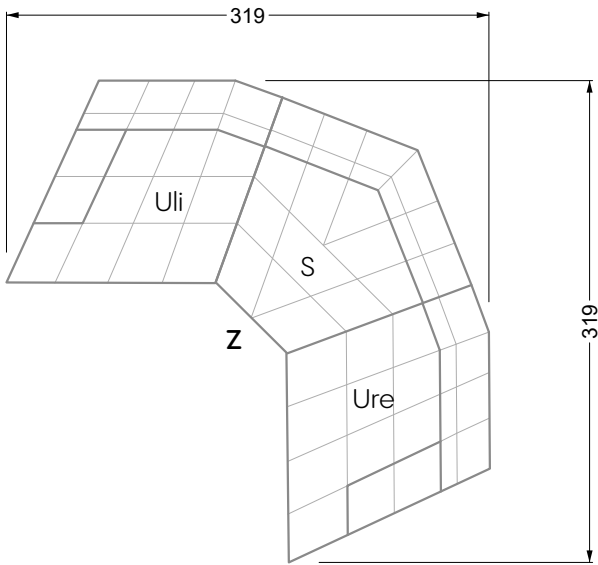

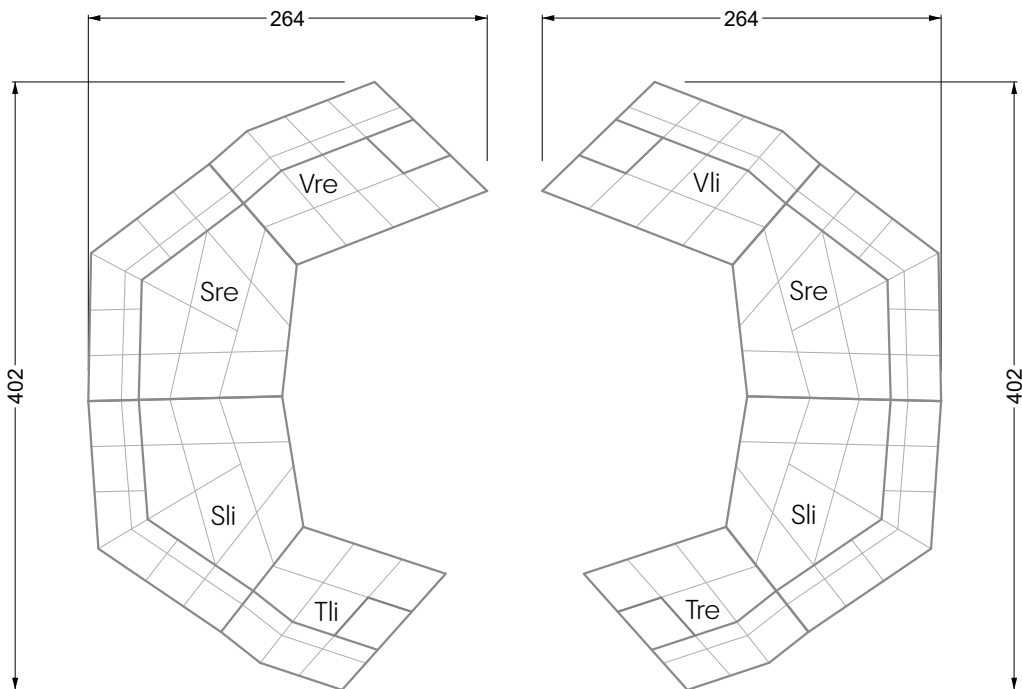
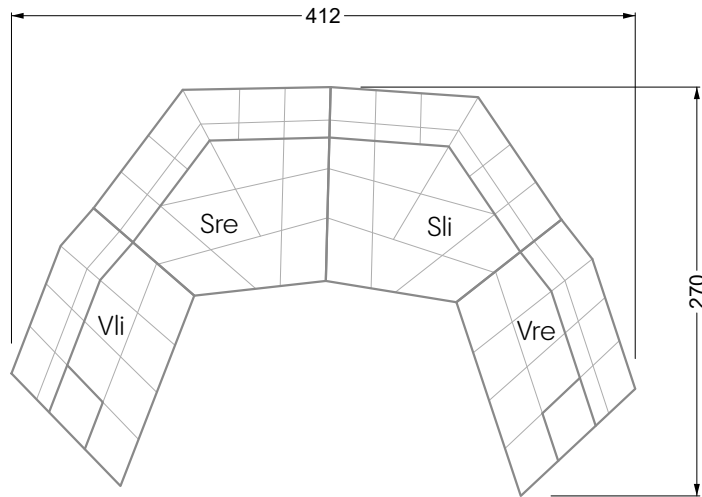
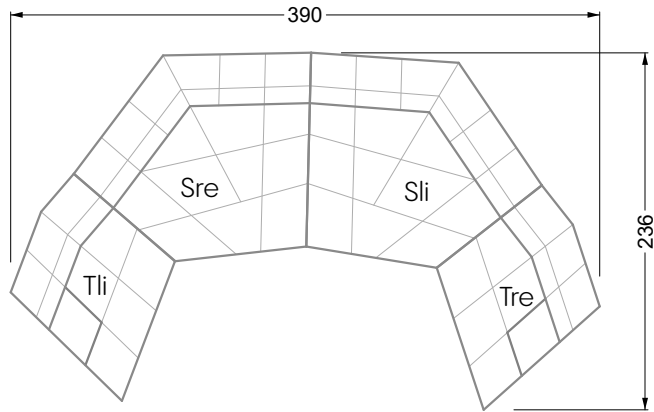

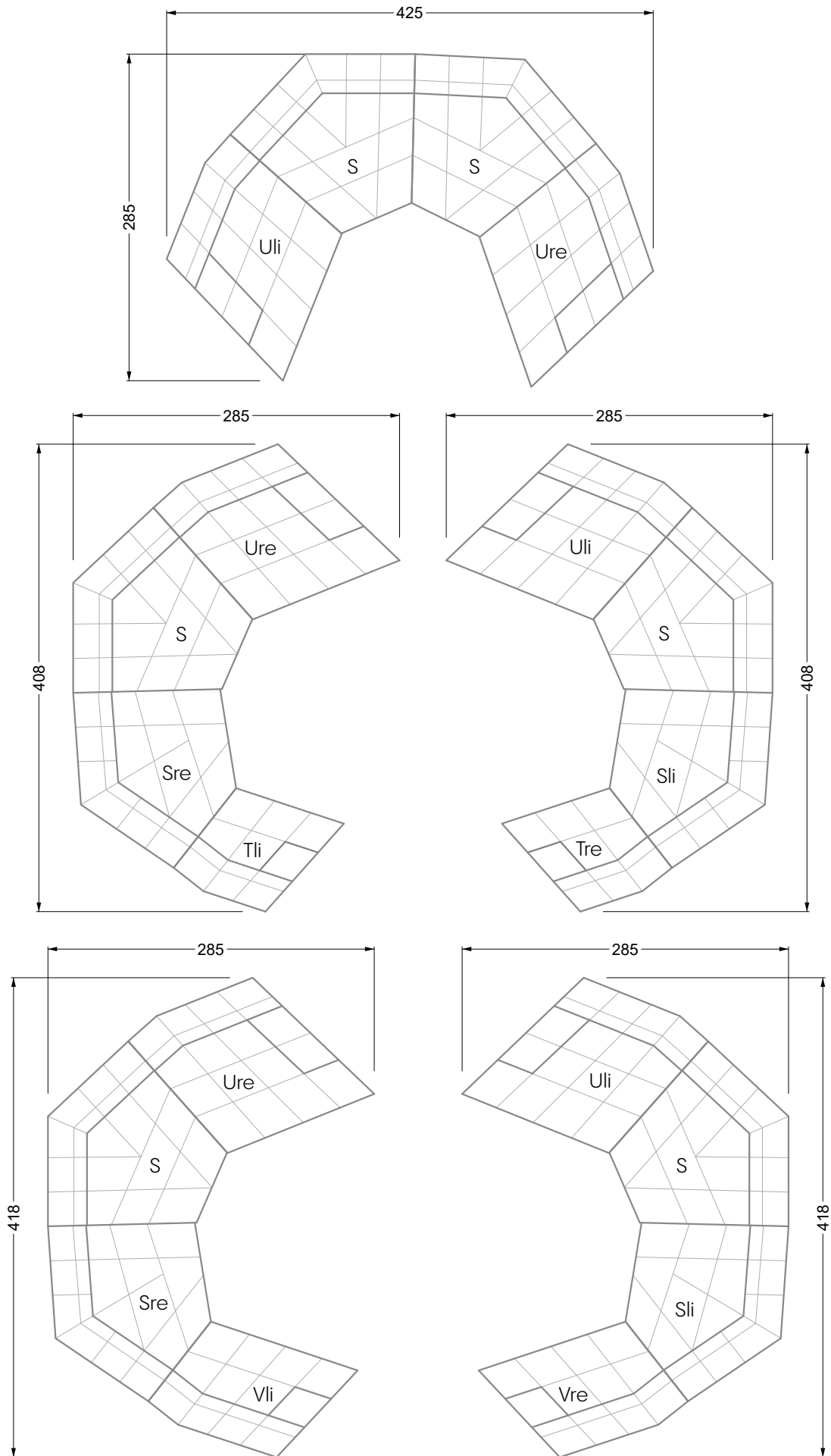

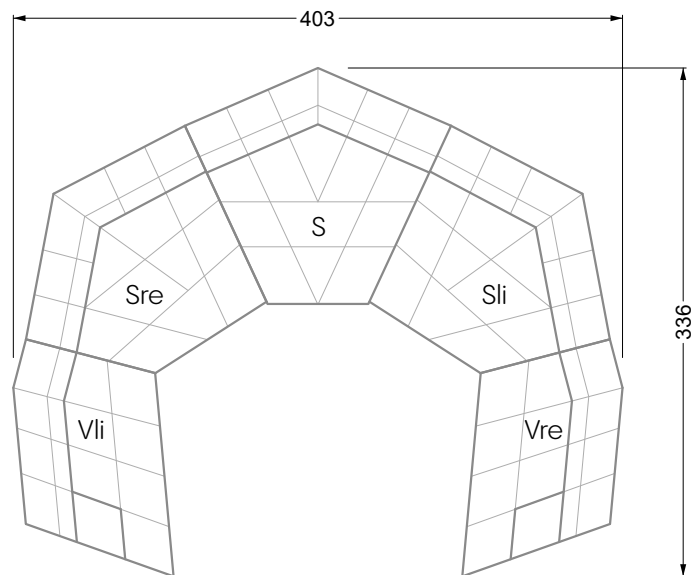
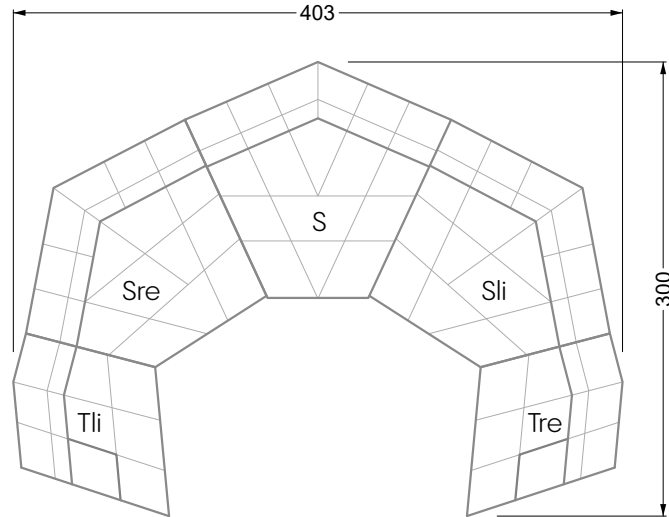

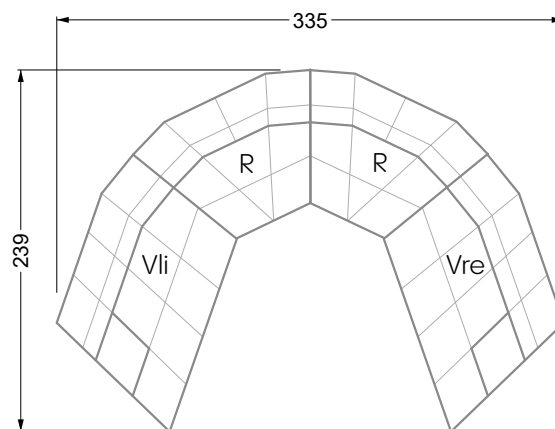
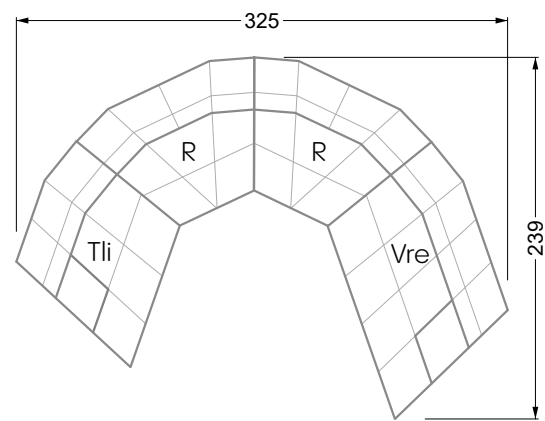
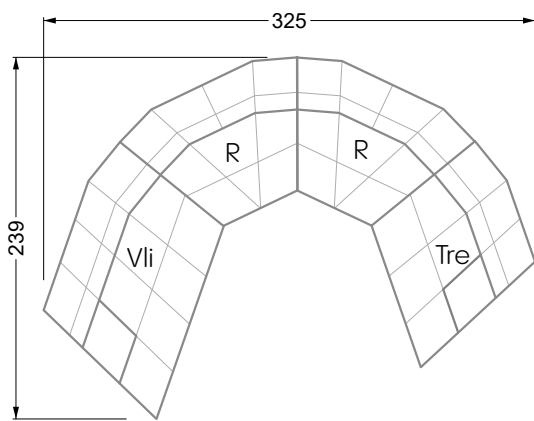
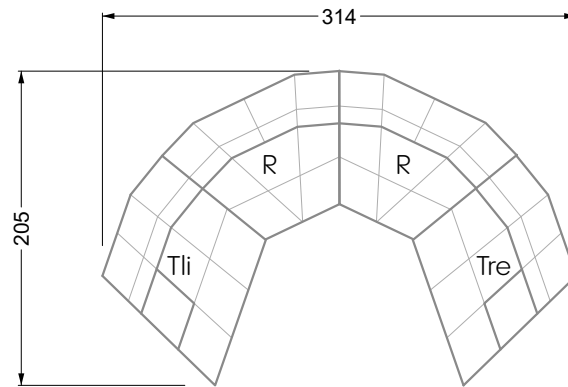

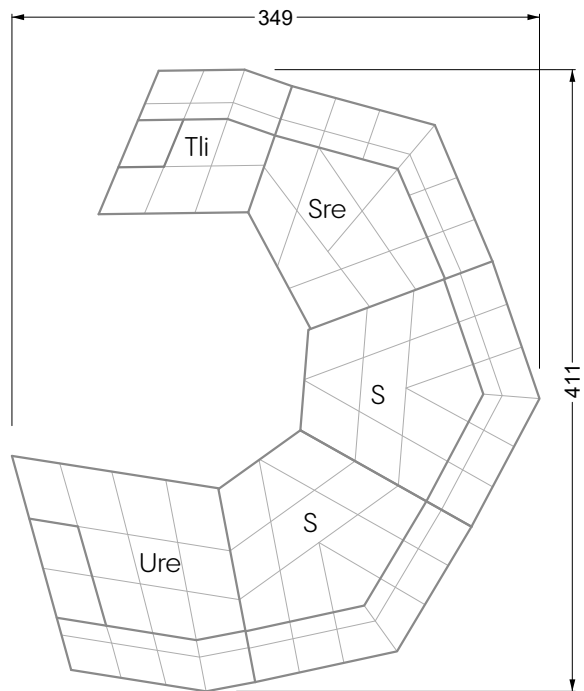
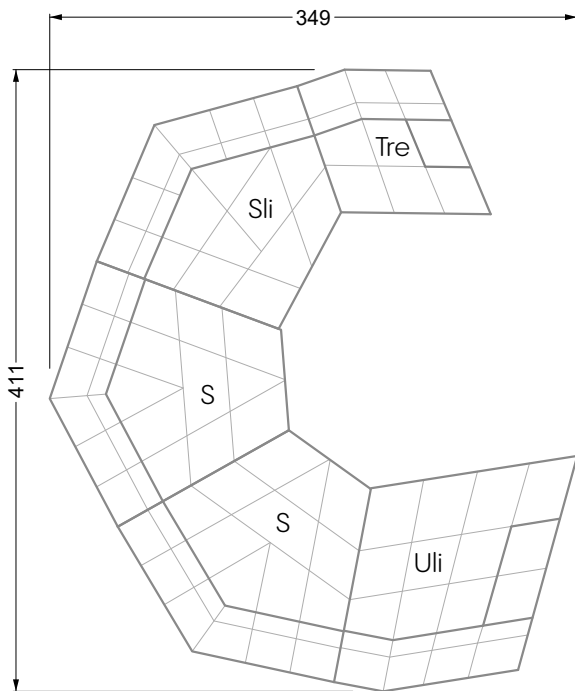
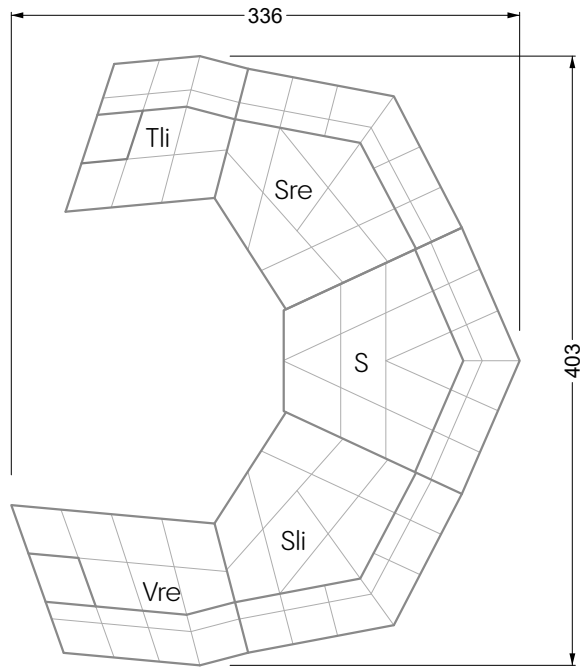
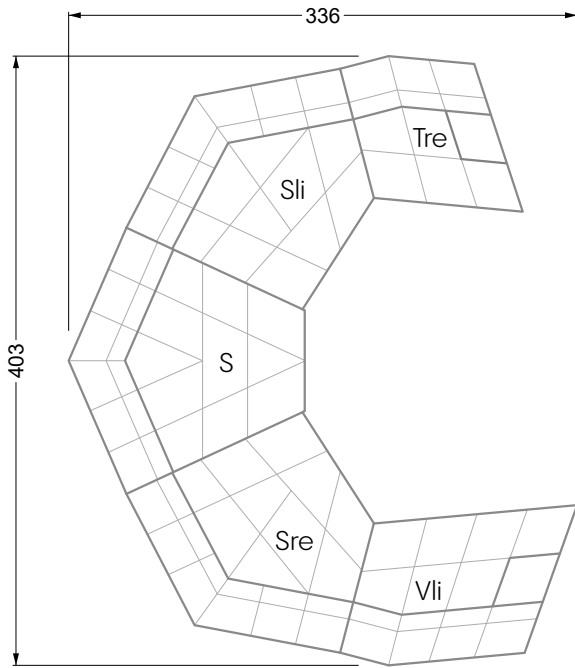

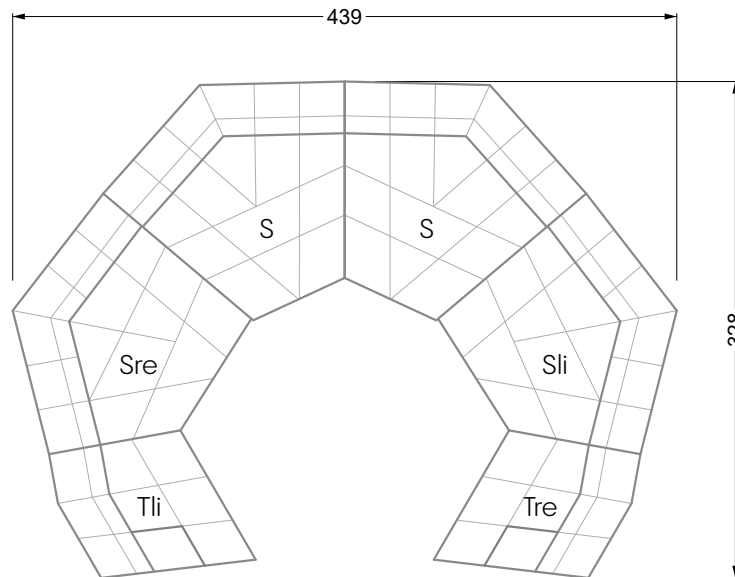
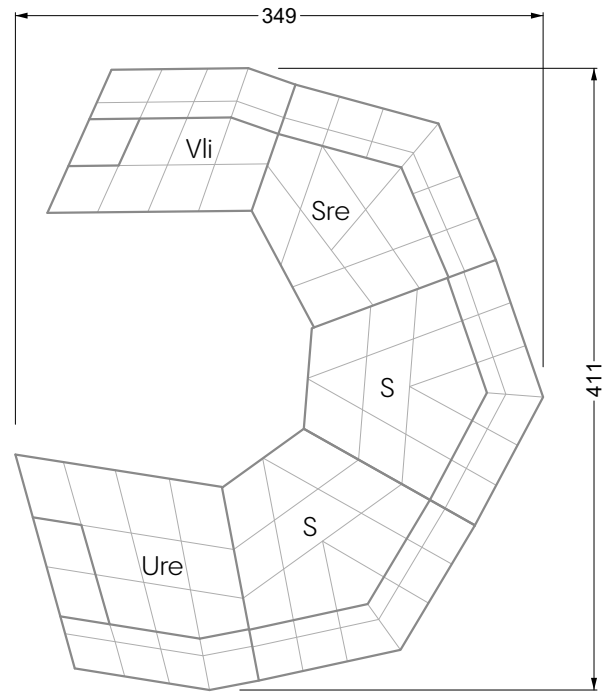
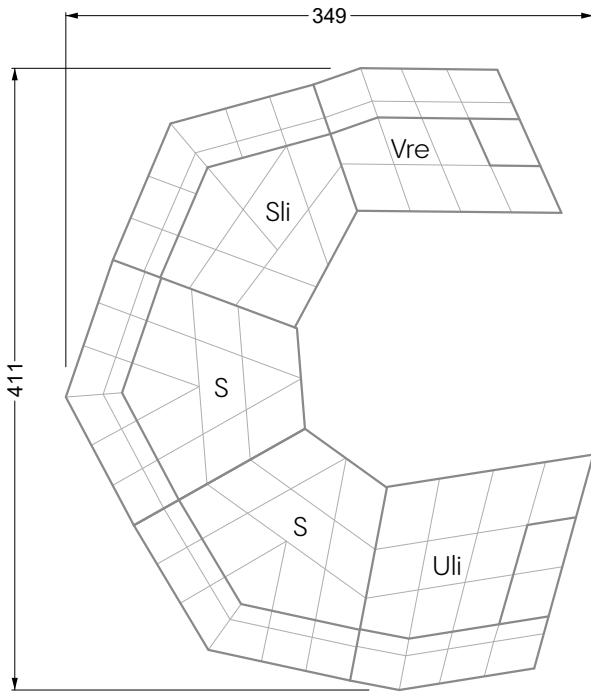



Bretz
German Manufacture
Since 1895

Head Office & Showroom:

Alexander-Bretz-Str. 2
D-55457 Gensingen
Tel +496727-895-0
E-Mail info@bretz.de

Bretz Sales Flagships & Partners:
bretz.de

f [BretzSofas](#)
@bretz_sofas

Bretz
True Characters