



swiss bed concept



LOUNGE

MASSIVHOLZ | BOIS MASSIF | SOLID WOOD

Achten Sie auf FSC®-zertifizierte Produkte | Soyez attentifs aux produits certifiés FSC® | Look for FSC®-certified products



Hasena – mein Bett

Hasena – mon lit | Hasena – my bed

Beständige Passion

Une passion constante
Enduring Passion

Mehr als ein Lebenswerk

Als Familienunternehmen gegründet, überzeugen wir seit über 70 Jahren mit hoher Qualität und Vielseitigkeit im Bereich Schlafzimmermöbel.

Plus que l'œuvre d'une vie

Fondée en tant qu'entreprise familiale, nous convainquons depuis plus de 70 ans par notre qualité élevée et notre polyvalence dans le domaine des meubles de chambre à coucher.

More than a life's work

Founded as a family business, we have been impressing with high quality and versatility in the field of bedroom furniture for over 70 years.



swiss bed concept



swiss bed concept

Ein cleveres Baukastensystem

Sie wählen Ihren favorisierten Bettrahmen aus und kombinieren dazu Füße und Kopfteil Ihrer Wahl. Dabei können Sie quer durch die Kollektionen auf unterschiedliche Materialien und Farben zugreifen.

Un système modulaire astucieux

Vous choisissez votre cadre de lit préféré et le combinez avec les pieds et les têtes de lit de votre choix. Vous pouvez choisir parmi une variété de matériaux et de couleurs dans toutes les collections.

A clever modular system

You choose your favourite bed frame and combine it with the feet and headboards of your choice. You can choose from a variety of materials and colours throughout the collections.

5 Jahre Garantie

Service de livraison rapide
5 years warranty



Unser Versprechen

Vom Baum zum Bett – mittels handwerklicher Perfektion und hochwertigen Materialien. Sie erhalten 5 Jahre Garantie auf die Material- und Oberflächenbeschaffenheit, sowie die fachgerechte Verarbeitung aller Modelle ab Kaufdatum. Weitere Informationen finden Sie auf unserer Website.

Notre promesse

De l'arbre au lit – grâce à un artisanat parfait et des matériaux de haute qualité. Vous bénéficiez d'une garantie de 5 ans sur la qualité des matériaux et des surfaces, ainsi que sur la fabrication professionnelle de tous les modèles à compter de la date d'achat. Vous trouverez plus d'informations sur notre site Internet.

Our promise

From tree to bed – by means of perfect craftsmanship and high-quality materials. You receive a 5-year guarantee on the material and surface quality, as well as the professional workmanship of all models from the date of purchase. Further information can be found on our website.

Schnellieferservice

Service de livraison rapide
Quick delivery service



Komfort ohne Wartezeit

Mit unserem Schnellieferservice «PRONTO» können wir eine grosse Auswahl an Betten mit Beimöbeln und alle Modelle aus Edition pronto, Dream pronto und Boxspring pronto ab Lager liefern.

Le confort sans attente

Notre service de livraison rapide « PRONTO » permet de livrer un large choix de lits, de meubles d'appoint et tous les modèles de l'Édition Pronto, Dream pronto et Boxspring Pronto à partir du stock.

Comfort without waiting

With our quick delivery service «PRONTO» we can offer a large selection of beds with ancillary furniture and all models from models from Edition pronto, Dream pronto and Boxspring pronto from stock.



Vielseitig kombinierbar

Unser ausgeklügeltes Baukastensystem «swiss bed concept» bietet eine riesige Auswahl an Füßen, Kopfteilen und Beimöbeln. Darüber hinaus umfasst es verschiedene Stoff-, Kunstleder- und Lederbezüge sowie diverse Holz- und Metallausführungen. Abgestimmte Lattenroste und Matratzen komplettieren unsere Betten zur Wohlfühloase.

Combinable à versatile

Notre système modulaire sophistiqué «swiss bed concept» propose un choix énorme de pieds, têtes de lits et accessoires. Par ailleurs le comporte différents tissus, cuirs synthétiques et véritables, ainsi que diverses variantes de bois et métal. Des sommiers à lattes et des matelas adaptés complètent nos lits pour un espace bien-être.

Versatile combinable

Our ingenious modular system «swiss bed concept» offers a huge selection of feet, headboards and accessories. In addition, it includes different fabrics, synthetic leather and real leather covers and different wood and metal versions. Matching slatted frames and mattresses complete our beds to an oasis of well-being.



Stabil im Aufbau

Unsere Betten überzeugen durch eine hohe Stabilität. Mittels Einsatz verschiedener Traversen ist eine gesamthafte Belastung von 300 bis 450 kg, inklusive Lattenroste und Matratzen, möglich.

Construction robuste

Nos lits sont convaincants par leur grande stabilité. En utilisant différentes fermes, une charge totale de 300 à 450 kg, y compris les sommiers à lattes et les matelas, est possible.

Solid in construction

Our beds convince with their high stability. By using different trusses, a total load of 300 to 450 kg, including slatted frames and mattresses, is possible.



Einfach in der Montage

Unser Betten-System begeistert durch einen einfachen Aufbau mit leicht verständlicher Montageanleitung sowie hochwertigen Verbindungselementen, welche einen vielfachen Ab- und Wiederaufbau ermöglichen.

Montage facile

Notre système de lits séduit par une installation facile grâce aux instructions de montage bien compréhensibles ainsi que par les éléments de fixation haut de gamme permettant de monter et démonter les lits à de nombreuses reprises.

Solid in construction

Our beds convince with their high stability. By using different trusses, a total load of 300 to 450 kg, including slatted frames and mattresses, is possible.

Nachhaltigkeit bei Hasena

Unser wichtigster Lieferant, die Natur, ist sensibel und benötigt lange Regenerationszeiten bei Überbeanspruchung. Wir respektieren die von uns genutzten Ökosysteme und stellen unsere Produkte nachhaltig und mit hohem sozialen Engagement her.

Durabilité chez Hasena

Notre fournisseur le plus important, la nature, est sensible et nécessite un long temps de régénération en cas de surutilisation. Nous respectons les écosystèmes que nous utilisons et fabriquons nos produits de manière durable et avec un haut niveau d'engagement social.

Sustainability at Hasena

Our most important supplier, nature, is sensitive and needs long regeneration times in case of overuse. We respect the ecosystems we use and manufacture our products sustainably and with a high level of social commitment.



Soziale Verantwortung

Responsabilité sociale
Social responsibility



Holzbeschaffung

Approvisionnement en bois
Wood procurement



Holzoberflächen

Surfaces en bois
Wood surfaces



Recycelte Stoffe

Tissus recyclés
Recycled fabrics



Produktion Massivholz

Production bois massif
Manufacturing solid wood



Energiegewinnung

Production énergétique
Production of energy



Bettrahmen | Cadre de lit | Bedframe

Lounge 18



Breiten | Largeurs | Widths
140, 160, 180 cm
Längen | Longueurs | Lengths
200, 210 cm
Einlegetiefe | Hauteur encastrable | Insertion depth:
18 cm

Traversen | Traverses | Bars

Wir empfehlen grundsätzlich den Einsatz von Crosstraver (Quertraverse) oder Midtraver (Längstraverse).
Nous recommandons en général l'utilisation de Crosstraver (traverse transversale) ou Midtraver (traverse centrale).
We recommend basically the insertion of Crosstraver (central cross bar) or Midtraver (central bar).

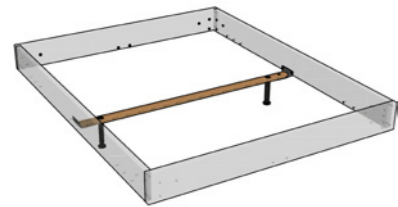

Crosstraver
Quertraverse | Traverse transversale | Central cross bar
Für alle Bettbreiten | Pour toutes les largeurs de lit | For all bed widths

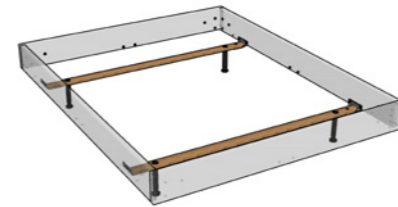

Crosstraver-Twin
Quertraversen | Traverses transversales | Cross bars
Für alle Bettbreiten | Pour toutes les largeurs de lit | For all bed widths

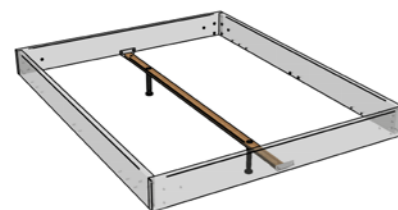

Midtraver
Längstraverse | Traverse centrale | Central bar
Für Betten ab Breite 140 cm mit 2 Lattenrosten oder Motorrahmen-einbau | Pour les lits à partir de 140 cm de largeur avec 2 sommiers ou l'installation d'un cadre motorisé | For beds from 140 cm width with 2 slats or motor frame installation

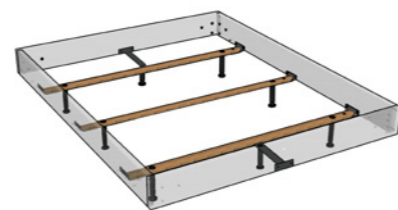

Crosstraver-XXL
Quertraversen | Traverses transversales | Cross bars
Für alle Bettbreiten | Pour toutes les largeurs de lit | For all bed widths

Übersicht Kompatibilität Traversen siehe Gesamtkatalog Seite 2.12 | Aperçu compatibilité traverses voir catalogue général page 2.12 | Overview compatibility bars see general catalogue page 2.12

Füsse | Pieds | Feet

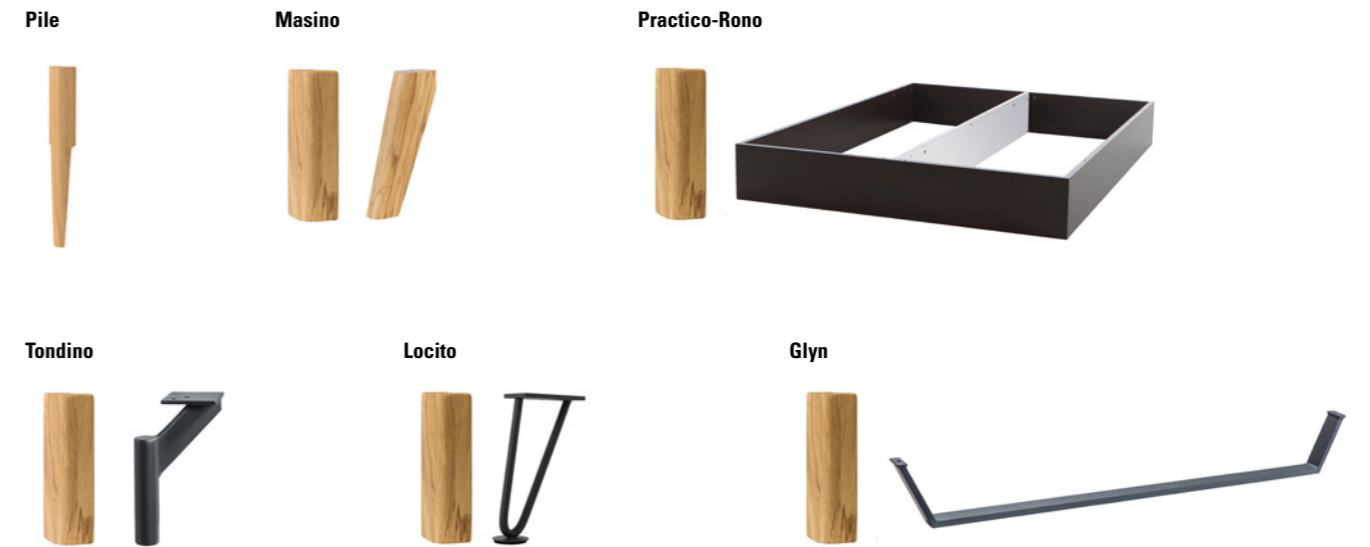

Holz | Bois | Wood

	Höhen cm Hauteurs cm Heights cm		Holzfarben Couleurs bois Colours wood					
	20	25	10	16	74	82	87	99
Pile	●	●	●	●	●	●	●	●
Practico-Rono*		●	●	●				●
Masino	●	●	●		●	●	●	●

*weiss/anthrazit = MDF | blanc/anthracite = MDF | white/anthracite = MDF

Metall | Métal | Metal

	Höhen cm Hauteurs cm Heights cm		Metallfarben Couleurs métal Colours metal	
	20	25	16	42
Tondino	●	●	●	●
Locito	●	●	●	●
Glyn	●	●	●	●

Holz | Bois | Wood

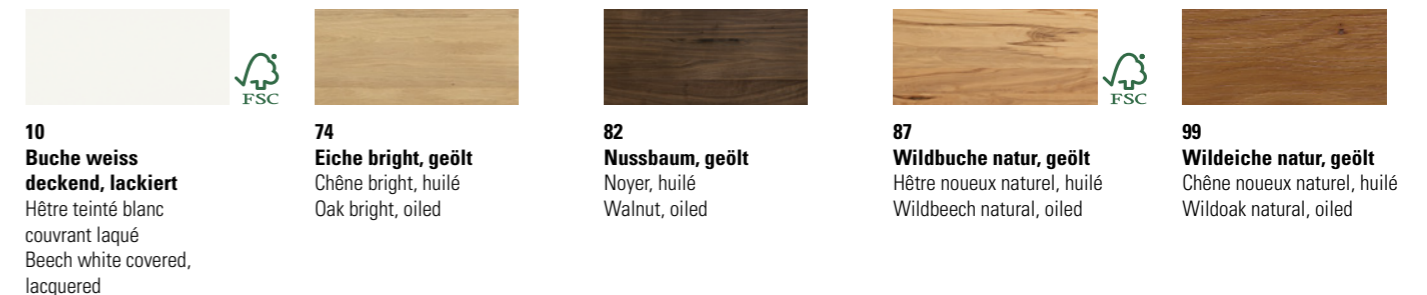

Metall | Métal | Metal



16 Anthracit = Stahl pulverbeschichtet | Acier thermolaqué | Steel powder-coated
42 Alu = Stahl pulverbeschichtet | Acier thermolaqué | Steel powder-coated

Kopfteile | Têtes de lit | Headboards

Wave



Dimension: 140, 160, 180

*Turano



Dimension: 140, 160, 180

Kulm



Dimension: 140, 160, 180

Lola + Kulm

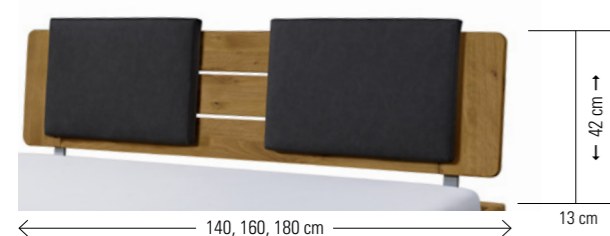

Dimension: 140, 160, 180

Comfy

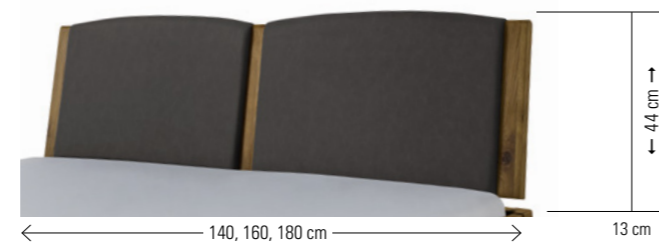

Dimension: 140, 160, 180

Lecco

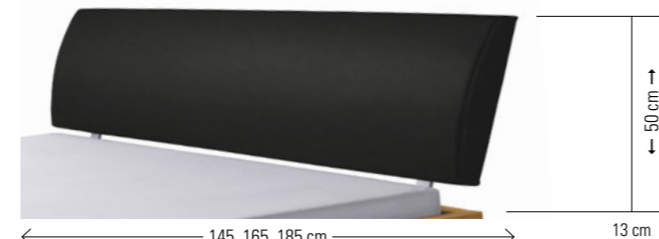

Dimension: 140, 160, 180

Boga



Dimension: 140, 160, 180

Stoff- und Kunstlederauswahl

Choix de tissus
Choice of tissues

Pepe (100 % Polyester)

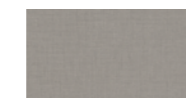

335 grey

Kul (Oberfläche | Surface 100% Polyurethan)

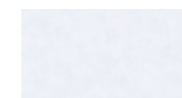

323 white



336 smoke

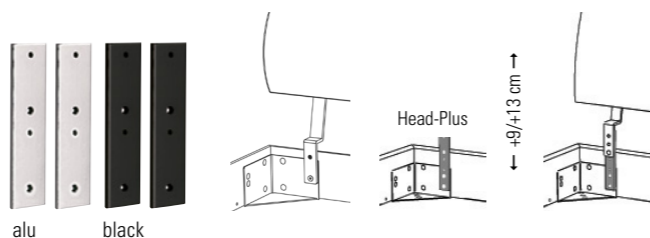

Adapter | Adaptateur | Adapter

Bei hohen Matratzen kann mit dem Verlängerungsadapter das Kopfteil erhöht werden.

La tête de lit peut être rehaussée avec l'adaptateur lorsque le matelas est plus épais. With the extension adapter the headboard can be extended if mattresses are high.

Head-Plus (2er Set | set de 2 | set of 2)

Head-Plus für Comfy | pour Comfy | for Comfy (3er Set | set de 3 | set of 3)

Metal | Métal | Metal

*ausschliesslich in Nussbaum 82, Wildbuche natur 87 und Wildeiche natur 99 | exclusivement en noyer 82, hêtre nouveau naturel 87 et chêne nouveau naturel 99 | exclusively in walnut 82, wildbeech natural and wildoak natural 99

Nachttische | Tables de nuit | Bedside tables



Drift



Seva



Stand



Surf

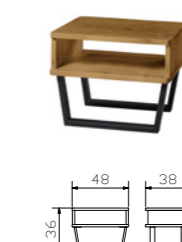

Styly



Ausführungen für Kopfteile und Nachttische | Exécutions pour tables de nuit et têtes de lit

Executions for bedside tables and headboards

<p>10 Buche weiss deckend, lackiert Hêtre teinté blanc couvrant laqué Beech white covered, lacquered</p>	<p>74 Eiche bright, geölt Chêne bright, huilé Oak bright, oiled</p>	<p>82 Nussbaum, geölt Noyer, huilé Walnut, oiled</p>	<p>87 Wildbuche natur, geölt Hêtre nouveau naturel, huilé Wildbeech natural, oiled</p>	<p>99 Wildeiche natur, geölt Chêne nouveau naturel, huilé Wildoak natural, oiled</p>
--	---	--	--	--

Bettkasten | Coffres à literie | Bedding boxes

Roll-Box 20/25



Roll-Box 20/25 + Covero



Roll-Box 20/25 + Saceto



Bettkasten in weiss oder anthrazit (Boden weiss)

Voraussetzung

Bettfusshöhe von mindestens 20 cm erforderlich

Optionen

Deckel Covero in weiss, Stoffabdeckung Saceto in Polyester grau.

Tiroir de lit en blanc ou anthracite (fond blanc)

Condition préalable

Une hauteur de pieds de lit d'au moins 20 cm.

Options

Couvercle Covero en blanc, tissu de protection Saceto en polyester gris.

Bed drawer in white or anthracite (bottom white)

Condition

Feet of bed need a minimum height of 20 cm.

Options

Cover Covero in white, tissue of protection Saceto in polyester grey.

Ausführungen für Bettkasten-Front | Exécutions pour façades coffres à literie | Executions for fronts of bedding boxes

<p>10 Buche weiss deckend, lackiert Hêtre teinté blanc couvrant, laqué Beech white covered, lacquered</p>	<p>16 Buche anthracit deckend, lackiert Hêtre teinté anthracite couvrant, laqué Beech anthracite covered, lacquered</p>	<p>74 Eiche bright, geölt Chêne bright, huilé Oak bright, oiled</p>	<p>93 Wildeiche natur, gebürstet, geölt Chêne nouveau naturel, brossé, huilé Wildoak natural, brushed, oiled</p>
---	---	---	--

selezione

01

MODELLAUSWAHL

Sélection du modèle | Model selection

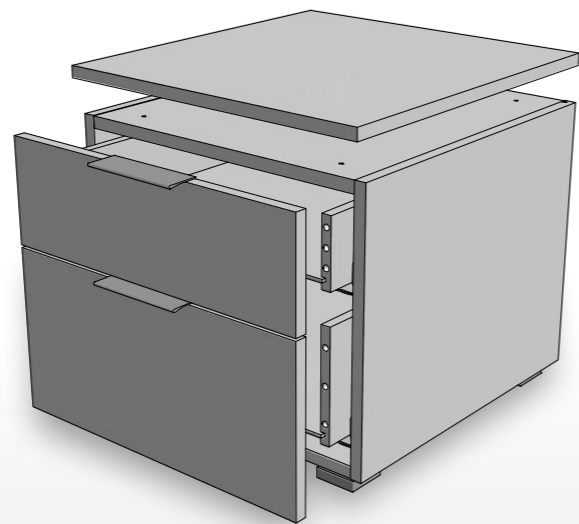

02

KORPUS

Caisson | Body



03

TOP/FRONT

Farben | Couleurs | Colours



04

GRIFFE

Poignées | Handles

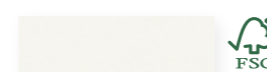
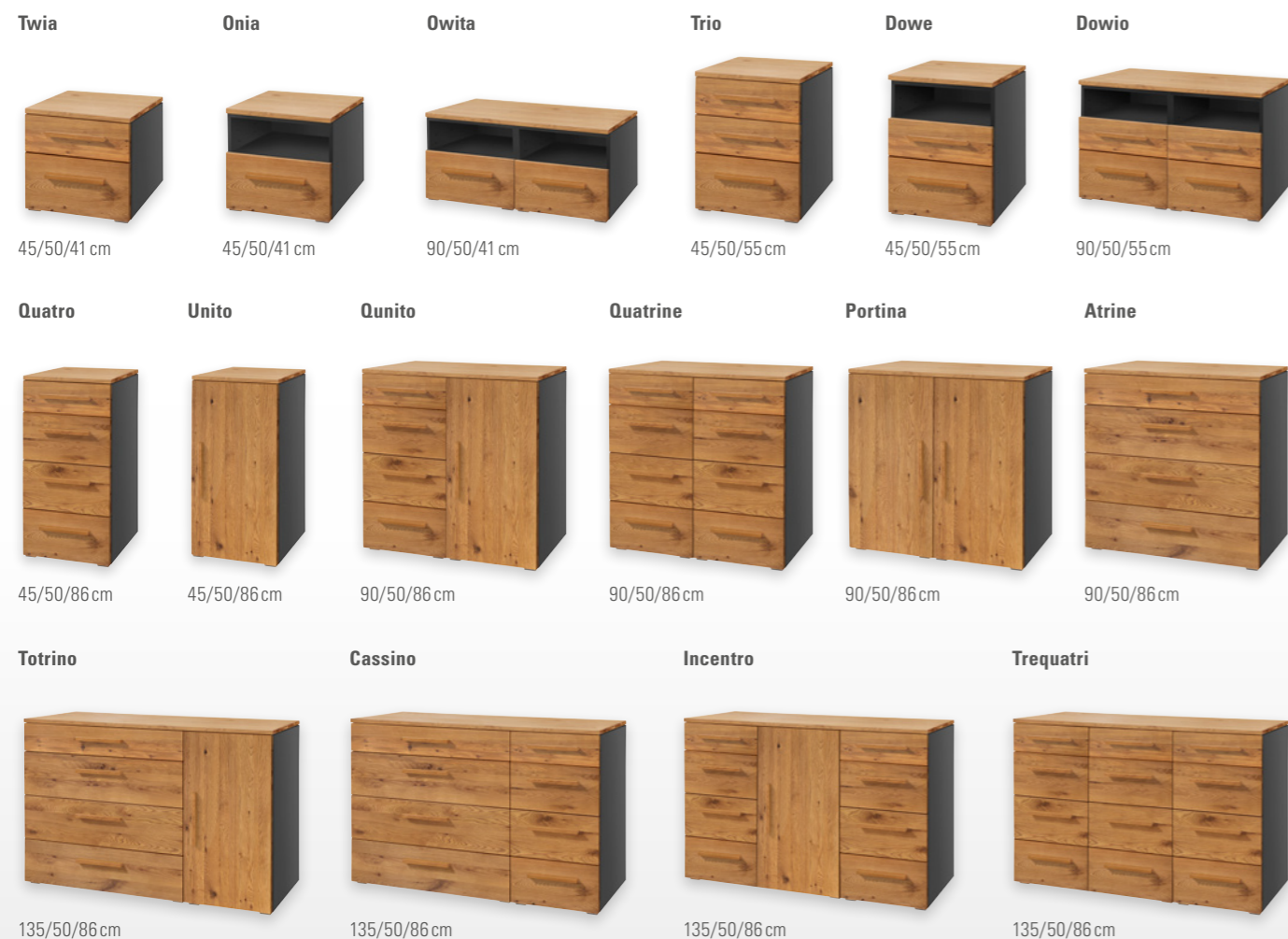

10 Weiss | Blanc | White



16 Anthracit | Anthracite

+ FÜSSE

Pieds | Feet

STANDARD



OPTION

Leg 8 cm



alu

Jone 10 cm



anthracit
used

Cila 10 cm



anthracit

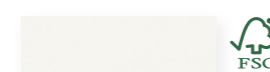

10 Weiss | Blanc | White



16 Anthracit | Anthracite

STANDARD



Alu

Griff zu Folienfronten

Poignée pour façades en mélaminé
Handle for foil fronts

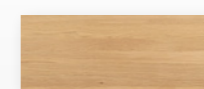

74 Eiche bright, geölt
Chêne bright, huilé
Oak bright, oiled

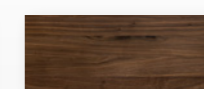

82 Nussbaum, geölt
Noyer, huilé
Walnut, oiled

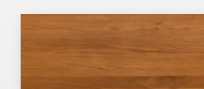

76 Eiche brandy, geölt
Chêne brandy, huilé
Oak brandy, oiled



87 Wildbuche natur, geölt
Hêtre nouveau naturel, huilé
Wildbeech natural, oiled



80 Kernbuche natur, geölt
Hêtre coeur rouge
naturel, huilé
Heart beech natural, oiled

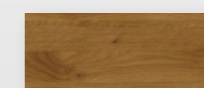

99 Wildeiche natur, geölt
Chêne nouveau naturel, huilé
Wildoak natural, oiled

STANDARD



Holzgriff zu Holzfronten

Poignée en bois pour façades en bois
Wooden handle for wooden fronts

OPTION

Rivo



Used

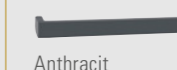

Anthracit

Metallgriff zu Holzfronten

Poignée en métal pour façades en bois
Metal handle for wooden fronts

Stellen Sie sich Ihr Wunsch-Beimöbel nach Ihrem Geschmack zusammen: Der Korpus (Abb. 02), in zwei verschiedenen Farbvarianten, lässt sich zu den Front- und Top-Covern (Abb. 03) in acht Holz- und Farbausführungen kombinieren. Die Beimöbel können zerlegt oder teilmontiert bestellt werden. Bei zusammengesetzten Möbeln (z. B. Qunito, Incentro, ...) muss der Deckel noch montiert werden. Bei Kommoden mit Türen ist jeweils ein Einlegeboden vorhanden, Türöffnung nach links oder rechts möglich. Zusätzliche Böden sind erhältlich.

Composez le meuble d'appoint de vos rêves selon vos goûts : Le caisson (ill. 02), disponible en 2 variantes de couleurs, peut être combiné avec les façades et couvercles supérieurs (ill. 03) en 8 finitions de bois et de coloris. Les meubles d'appoint peuvent être commandés en kits ou assemblés. Pour les meubles assemblés (p. ex. Qunito, Incentro, ...) le couvercle doit encore être fixé. Les commodes avec portes sont équipées d'une étagère, ouverture de la porte possible à gauche ou à droite. Si besoin, des étagères supplémentaires sont disponibles.

Put together the side furniture you want according to your own taste: The body (fig. 02), in two different colour versions, can be combined with the front and top covers (fig. 03) in eight wood and colour versions. The furniture can be ordered disassembled or assembled. For assembled furniture (e.g. Qunito, Incentro, ...) the top cover must still be fitted. Chests of drawers with doors have one shelf, door opening possible to the left or right. Additional shelves are available.



Kombinationsbeispiele
und techn. Informationen
Exemples et informations
Examples and informations





				Dimension cm
Surf anthracit	Nachttisch	Table de nuit	Bedside table	48/38/36

				Dimension cm
Lounge 18	Rahmen Breiten Längen	Cadre Largeurs Longueurs	Frame Widths Lengths	140, 160, 180 200, 210
Glyn anthracit	Füße Höhen	Pieds Hauteurs	Feet Heights	20, 25
Wave	Kopfteil	Tête de lit	Headboard	140, 160, 180



Alle Holzteile in Nussbaum, geölt | Toutes les parties en bois en noyer, huilé | All wooden parts in walnut, oiled
 Weitere Beimöbel siehe Gesamtkatalog Register 2 | Autres accessoires voir catalogue général registre 2 | Further accessories see general catalogue index 2

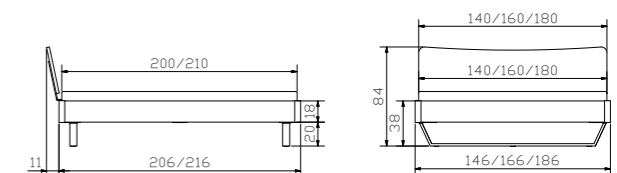

1



2



3



4



1. Holzteile in Wildeiche natur, geölt | Parties en bois en chêne nouveau naturel, huilé | All wooden parts in wildoak natural, oiled

2. Holzteile in Buche weiss, deckend, lackiert | Parties en bois en hêtre teinté blanc couvrant, laqué | All wooden parts in beech white covered, lacquered

3. Holzteile in Nussbaum, geölt | Parties en bois en noyer, huilé | All wooden parts in walnut, oiled

4. Holzteile in Eiche bright, geölt | Parties en bois en chêne bright, huilé | All wooden parts in oak bright, oiled

**Lounge 18**

Rahmen
Breiten
Längen

Cadre
Largeurs
Longueurs

Frame
Widths
lengths

Dimension cm

140, 160, 180
200, 210

Pile

Füsse
Höhen

Pieds
Hauteurs

Feet
Heights

20, 25

Kulm

Kopfteil

Tête de lit

Headboard

140, 160, 180

Seva

Nachttisch

Table de nuit

Bedside table

48/38/16

**Alle Holzteile in Wildbuche natur, geölt**

Toutes les parties en bois en hêtre nouveau naturel, huilé
All wooden parts in wildbeech natural, oiled

Weitere Beimöbel siehe Gesamtkatalog Register 2

Autres accessoires voir catalogue général registre 2
Further accessories see general catalogue index 2

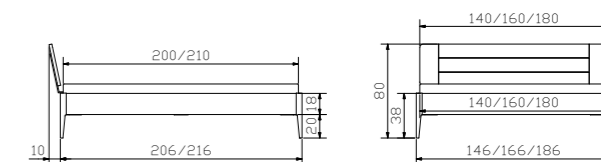



				Dimension cm
Drift	Nachttisch	Table de nuit	Bedside table	48/38/9

				Dimension cm
Lounge 18	Rahmen Breiten Längen	Cadre Largeurs Longueurs	Frame Widths Lengths	140, 160, 180 200, 210
Pile	Füsse Höhen	Pieds Hauteurs	Feet Heights	20, 25
Lecco	Kopfteil Pepe grey 335	Tête de lit Pepe grey 335	Headboard Pepe grey 335	140, 160, 180



Alle Holzteile in Buche weiss, deckend, lackiert | Toutes les parties en bois en hêtre teinté blanc couvrant, laqué | All wooden parts in beech white covered, lacquered
Weitere Beimöbel siehe Gesamtkatalog Register 2 | Autres accessoires voir catalogue général registre 2 | Further accessories see general catalogue index 2

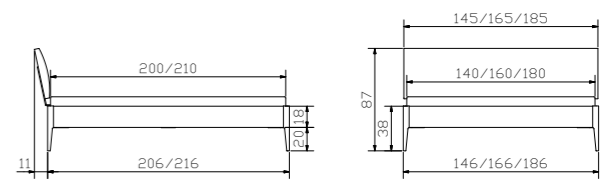



Style	Nachttisch	Table de nuit	Beside table	Dimension cm
				43/43/48

	Dimension cm		
Lounge 18	Rahmen Breiten Längen	Cadre Largeurs Longueurs	Frame Widths Lengths
			140, 160, 180 200, 210
Pile	Füsse Höhen	Pieds Hauteurs	Feet Heights
			20, 25
Boga	Kopfteil Pepe grey 335	Tête de lit Pepe grey 335	Headboard Pepe grey 335
			140, 160, 180



Alle Holzteile in Eiche bright, geölt | Toutes les parties en bois en chêne bright, huilé | All wooden parts in oak bright, oiled
 Weitere Beimebel siehe Gesamtkatalog Register 2 | Autres accessoires voir catalogue général registre 2 | Further accessories see general catalogue index 2

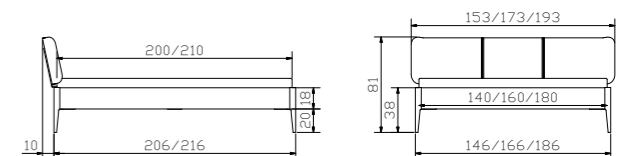



				Dimension cm
Surf anthracit	Nachttisch	Table de nuit	Bedside table	48/38/36

				Dimension cm
Lounge 18	Rahmen Breiten Längen	Cadre Largeurs Longueurs	Frame Widths Lengths	140, 160, 180 200, 210
Glyn anthracit	Kufen Breiten Höhen	Patins Largeurs Hauteurs	Vats Widths Heights	140, 160, 180 20, 25
Turano	Kopfteil	Tête de lit	Headboard	140, 160, 180



Alle Holzteile in Wildeiche natur, geölt | Toutes les parties en bois en chêne naturel, huilé | All wooden parts in wildoak natural, oiled
 Weitere Beimebel siehe Gesamtkatalog Register 2 | Autres accessoires voir catalogue général registre 2 | Further accessories see general catalogue index 2

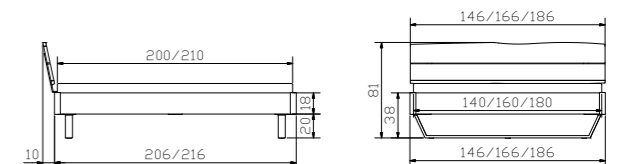

1



2



3



- 1. Holzteile in Wildeiche natur, geölt** | Parties en bois en chêne nouveau naturel, huilé | Wooden parts in wildoak natural, oiled
2. Holzteile in Eiche bright, geölt | Parties en bois en chêne bright, huilé | Wooden parts in oak bright, oiled
3. Holzteile in Wildbuche natur, geölt | Parties en bois en hêtre nouveau naturel, huilé | Wooden parts in wildbeech natural, oiled



				Dimension cm
Lounge 18	Rahmen	Cadre	Frame	
	Breiten	Largeurs	Widths	140, 160, 180
	Längen	Longueurs	Lengths	200, 210
Locito anthracit	Füsse	Pieds	Feet	
	Höhe	Hauteur	Height	20
Lecco	Kopfteil	Tête de lit	Headboard	
	Kul smoke 336	Kul smoke 336	Kul smoke 336	140, 160, 180
Dowe	Nachttisch	Table de nuit	Bedside table	
	Cila 10 anthracit	Füsse	Feet	45/50/55 10



Alle Holzteile in Nussbaum, geölt
 Toutes les parties en bois en noyer, huilé
 All wooden parts in walnut, oiled

Weitere Beimöbel siehe Gesamtkatalog Register 2 | Autres accessoires voir catalogue général registre 2 | Further accessories see general catalogue index 2

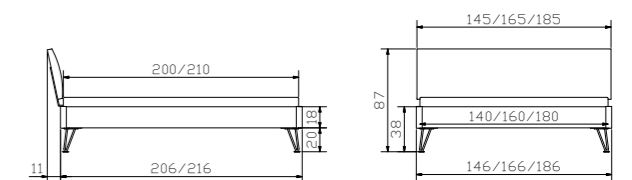



				Dimension cm
Seva	Nachttisch	Table de nuit	Beside table	48/38/16

				Dimension cm
Lounge 18	Rahmen Breiten Längen	Cadre Largeurs Longueurs	Frame Widths Lengths	140, 160, 180 200, 210
Tondino anthracit	Füsse Höhe	Pieds Hauteur	Feet Height	20
Lecco	Kopfteil Kul smoke 336	Tête de lit Kul smoke 336	Headboard Kul smoke 336	140, 160, 180



Alle Holzteile in Wildbuche natur, geölt | Toutes les parties en hêtre nouveau naturel, huilé | All wooden parts in wildbeech natural, oiled
Weitere Beimöbel siehe Gesamtkatalog Register 2 | Autres accessoires voir catalogue général registre 2 | Further accessories see general catalogue index 2

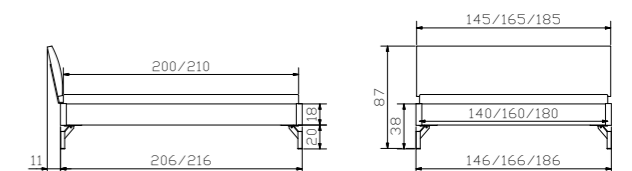



Style	Nachttisch	Table de nuit	Beside table	Dimension cm
				43/43/48

	Rahmen	Cadre	Frame	Dimension cm
Lounge 18	Breiten Längen	Largeurs Longueurs	Widths Lengths	140, 160, 180 200, 210
Pile	Füsse Höhen	Pieds Hauteurs	Feet Heights	20, 25
Wave	Kopfteil	Tête de lit	Headboard	140, 160, 180



Roll-Box 20 + 25
Wildeiche natur, gebürstet, geölt
 Chêne nouveau naturel, brossé, huilé
 Wildoak natural, brushed, oiled



Alle Holzteile in Wildeiche natur, geölt
 Toutes les parties en bois en chêne nouveau naturel, huilé
 All wooden parts in wildoak natural, oiled

Weitere Beimöbel siehe Gesamtkatalog Register 2
 Autres accessoires voir catalogue général registre 2
 Further accessories see general catalogue index 2

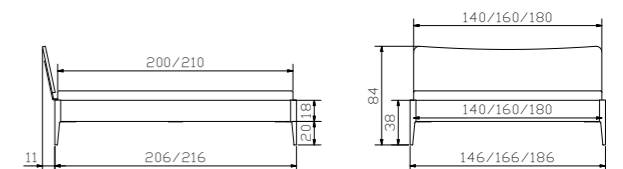



				Dimension cm
Seva	Nachttisch	Table de nuit	Bedside table	48/38/16

				Dimension cm
Lounge 18	Rahmen Breiten Längen	Cadre Largeurs Longueurs	Frame Widths Lengths	140, 160, 180 200, 210
Pile	Füsse Höhen	Pieds Hauteurs	Feet Heights	20, 25
Comfy	Kopfteil Pepe grey 335	Tête de lit Pepe grey 335	Headboard Pepe grey 335	140, 160, 180



Alle Holzteile in Buche weiss, deckend, lackiert | Toutes les parties en bois en hêtre teinté blanc couvrant, laqué | All wooden parts in beech white covered, lacquered

Weitere Beimöbel siehe Gesamtkatalog Register 2 | Autres accessoires voir catalogue général registre 2 | Further accessories see general catalogue index 2

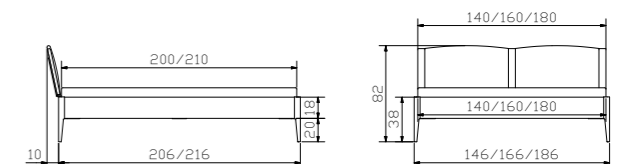



				Dimension cm
Stand	Nachttisch	Table de nuit	Beside table	48/38/42

				Dimension cm
Lounge 18	Rahmen Breiten Längen	Cadre Largeurs Longueurs	Frame Widths Lengths	140, 160, 180 200, 210
Masino	Füße Höhen	Pieds Hauteurs	Feet Heights	20, 25
Kulm	Kopfteil	Tête de lit	Headboard	140, 160, 180



Alle Holzteile in Eiche bright, geölt | Toutes les parties en bois en chêne bright, huilé | All wooden parts in oak bright, oiled
Weitere Beimöbel siehe Gesamtkatalog Register 2 | Autres accessoires voir catalogue général registre 2 | Further accessories see general catalogue index 2

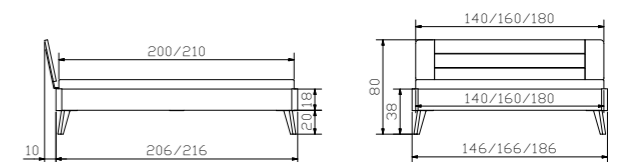



				Dimension cm
Surf anthracit	Nachttisch	Table de nuit	Bedside table	48/38/36

				Dimension cm
Lounge 18	Rahmen Breiten Längen	Cadre Largeurs Longueurs	Frame Widths Lengths	140, 160, 180 200, 210
Glyn anthracit	Füsse Höhen	Pieds Hauteurs	Feet Heights	20, 25
Comfy	Kopfteil Kul smoke 336	Tête de lit Kul smoke 336	Headboard Kul smoke 336	140, 160, 180



Alle Holzteile in Wildeiche natur, geölt | Toutes les parties en bois en chêne nouveau naturel, huilé | All wooden parts in wildoak natural, oiled
Weitere Beimöbel siehe Gesamtkatalog Register 2 | Autres accessoires voir catalogue général registre 2 | Further accessories see general catalogue index 2

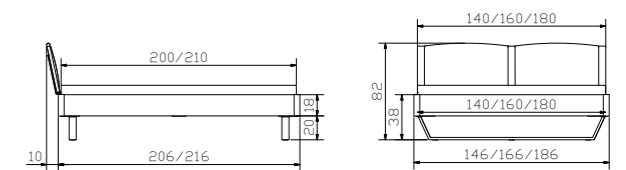



MOVIE-/TOP LINE



FACTORY LINE



WOOD LINE



LOUNGE



FINE LINE



NATURO LINE



OAK LINE



OAK WILD



DREAM LINE



**EDITION
BOXSPRING**



**FUNCTION/COMFORT
KIDS & GUESTS**



**LATTENROSTE &
MATRATZEN**



Gesamtkatalog
Catalogue général
General catalogue