



swiss bed concept

HASENA
the dream factory



OAKLINE/BIANCO

EICHE MASSIV | CHÊNE MASSIF | SOLID OAK

Achten Sie auf FSC®-zertifizierte Produkte | Soyez attentifs aux produits certifiés FSC® | Look for FSC®-certified products



Hasena – mein Bett

Hasena – mon lit | Hasena – my bed

Beständige Passion

Une passion constante
Enduring Passion

Mehr als ein Lebenswerk

Als Familienunternehmen gegründet, überzeugen wir seit über 70 Jahren mit hoher Qualität und Vielseitigkeit im Bereich Schlafzimmere Möbel.

Plus que l'œuvre d'une vie

Fondée en tant qu'entreprise familiale, nous convainquons depuis plus de 70 ans par notre qualité élevée et notre polyvalence dans le domaine des meubles de chambre à coucher.

More than a life's work

Founded as a family business, we have been impressing with high quality and versatility in the field of bedroom furniture for over 70 years.



swiss bed concept



swiss bed concept

Ein cleveres Baukastensystem

Sie wählen Ihren favorisierten Bettrahmen aus und kombinieren dazu Füße und Kopfteil Ihrer Wahl. Dabei können Sie quer durch die Kollektionen auf unterschiedliche Materialien und Farben zugreifen.

Un système modulaire astucieux

Vous choisissez votre cadre de lit préféré et le combinez avec les pieds et les têtes de lit de votre choix. Vous pouvez choisir parmi une variété de matériaux et de couleurs dans toutes les collections.

A clever modular system

You choose your favourite bed frame and combine it with the feet and headboards of your choice. You can choose from a variety of materials and colours throughout the collections.

5 Jahre Garantie

Service de livraison rapide
5 years warranty



Unser Versprechen

Vom Baum zum Bett – mittels handwerklicher Perfektion und hochwertigen Materialien. Sie erhalten 5 Jahre Garantie auf die Material- und Oberflächenbeschaffenheit, sowie die fachgerechte Verarbeitung aller Modelle ab Kaufdatum. Weitere Informationen finden Sie auf unserer Website.

Notre promesse

De l'arbre au lit – grâce à un artisanat parfait et des matériaux de haute qualité. Vous bénéficiez d'une garantie de 5 ans sur la qualité des matériaux et des surfaces, ainsi que sur la fabrication professionnelle de tous les modèles à compter de la date d'achat. Vous trouverez plus d'informations sur notre site Internet.

Our promise

From tree to bed – by means of perfect craftsmanship and high-quality materials. You receive a 5-year guarantee on the material and surface quality, as well as the professional workmanship of all models from the date of purchase. Further information can be found on our website.

Schnellieferservice

Service de livraison rapide
Quick delivery service



Komfort ohne Wartezeit

Mit unserem Schnellieferservice «PRONTO» können wir eine grosse Auswahl an Betten mit Beimöbeln und alle Modelle aus Edition pronto, Dream pronto und Boxspring pronto ab Lager liefern.

Le confort sans attente

Notre service de livraison rapide « PRONTO » permet de livrer un large choix de lits, de meubles d'appoint et tous les modèles de l'Édition Pronto, Dream pronto et Boxspring Pronto à partir du stock.

Comfort without waiting

With our quick delivery service «PRONTO» we can offer a large selection of beds with ancillary furniture and all models from models from Edition pronto, Dream pronto and Boxspring pronto from stock.



Vielseitig kombinierbar

Unser ausgeklügeltes Baukastensystem «swiss bed concept» bietet eine riesige Auswahl an Füßen, Kopfteilen und Beimöbeln. Darüber hinaus umfasst es verschiedene Stoff-, Kunstleder- und Lederbezüge sowie diverse Holz- und Metallausführungen. Abgestimmte Lattenroste und Matratzen komplettieren unsere Betten zur Wohlfühloase.

Combinable à versatile

Notre système modulaire sophistiqué «swiss bed concept» propose un choix énorme de pieds, têtes de lits et accessoires. Par ailleurs le comporte différents tissus, cuirs synthétiques et véritables, ainsi que diverses variantes de bois et métal. Des sommiers à lattes et des matelas adaptés complètent nos lits pour un espace bien-être.

Versatile combinable

Our ingenious modular system «swiss bed concept» offers a huge selection of feet, headboards and accessories. In addition, it includes different fabrics, synthetic leather and real leather covers and different wood and metal versions. Matching slatted frames and mattresses complete our beds to an oasis of well-being.



Stabil im Aufbau

Unsere Betten überzeugen durch eine hohe Stabilität. Mittels Einsatz verschiedener Traversen ist eine gesamthafte Belastung von 300 bis 450 kg, inklusive Lattenroste und Matratzen, möglich.

Construction robuste

Nos lits sont convaincants par leur grande stabilité. En utilisant différentes fermes, une charge totale de 300 à 450 kg, y compris les sommiers à lattes et les matelas, est possible.

Solid in construction

Our beds convince with their high stability. By using different trusses, a total load of 300 to 450 kg, including slatted frames and mattresses, is possible.



Einfach in der Montage

Unser Betten-System begeistert durch einen einfachen Aufbau mit leicht verständlicher Montageanleitung sowie hochwertigen Verbindungselementen, welche einen vielfachen Ab- und Wiederaufbau ermöglichen.

Montage facile

Notre système de lits séduit par une installation facile grâce aux instructions de montage bien compréhensibles ainsi que par les éléments de fixation haut de gamme permettant de monter et démonter les lits à de nombreuses reprises.

Solid in construction

Our beds convince with their high stability. By using different trusses, a total load of 300 to 450 kg, including slatted frames and mattresses, is possible.

Nachhaltigkeit bei Hasena

Unser wichtigster Lieferant, die Natur, ist sensibel und benötigt lange Regenerationszeiten bei Überbeanspruchung. Wir respektieren die von uns genutzten Ökosysteme und stellen unsere Produkte nachhaltig und mit hohem sozialen Engagement her.

Durabilité chez Hasena

Notre fournisseur le plus important, la nature, est sensible et nécessite un long temps de régénération en cas de surutilisation. Nous respectons les écosystèmes que nous utilisons et fabriquons nos produits de manière durable et avec un haut niveau d'engagement social.

Sustainability at Hasena

Our most important supplier, nature, is sensitive and needs long regeneration times in case of overuse. We respect the ecosystems we use and manufacture our products sustainably and with a high level of social commitment.



Soziale Verantwortung

Responsabilité sociale
Social responsibility



Holzbeschaffung

Approvisionnement en bois
Wood procurement



Produktion Massivholz

Production bois massif
Manufacturing solid wood



Holzoberflächen

Surfaces en bois
Wood surfaces



Recycelte Stoffe

Tissus recyclés
Recycled fabrics



Energiegewinnung

Production énergétique
Production of energy



OAK LINE

EICHE MASSIV | CHÊNE MASSIF | SOLID OAK



Bettrahmen | Cadre de lit | Bedframe

Modul 18

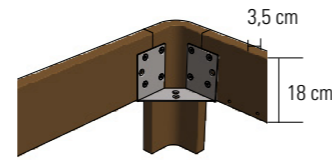

Breiten | Largeurs | Widths:
90, 100, 120, 140, 160, 180, 200 cm

Längen | Longueurs | Lengths:
190, 200, 210, 220 cm

Einlegetiefe | Hauteur encastrable | Insertion depth:
18 cm

Traversen | Traverses | Bars

Wir empfehlen grundsätzlich den Einsatz von Crosstraver (Quertraverse) oder Midtraver (Längstraverse).
Nous recommandons en général l'utilisation de Crosstraver (traverse transversale) ou Midtraver (traverse centrale).
We recommend basically the insertion of Crosstraver (central cross bar) or Midtraver (central bar).

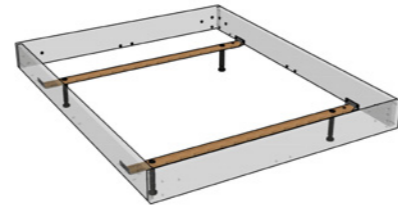
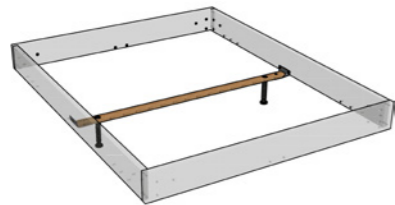

Crosstraver
Quertraverse | Traverse transversale | Central cross bar
Für alle Bettbreiten | Pour toutes les largeurs de lit | For all bed widths

Crosstraver-Twin
Quertraversen | Traverses transversales | Cross bars
Für alle Bettbreiten | Pour toutes les largeurs de lit | For all bed widths

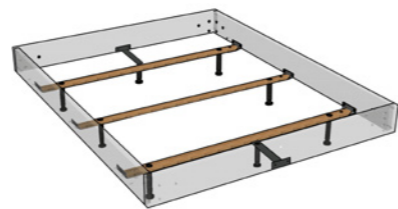
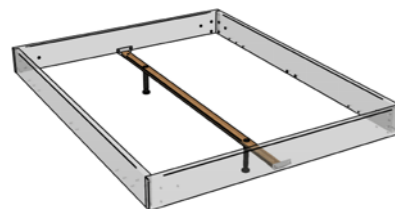

Midtraver
Längstraverse | Traverse centrale | Central bar
Für Betten ab Breite 140 cm mit 2 Lattenrosten oder Motorrahmen-einbau | Pour les lits à partir de 140 cm de largeur avec 2 sommiers ou l'installation d'un cadre motorisé | For beds from 140 cm width with 2 slats or motor frame installation

Crosstraver-XXL
Quertraversen | Traverses transversales | Cross bars
Für alle Bettbreiten | Pour toutes les largeurs de lit | For all bed widths

Übersicht Kompatibilität Traversen siehe Gesamtkatalog Seite 2.12 | Aperçu compatibilité traverses voir catalogue général page 2.12 | Overview compatibility bars see general catalogue page 2.12

Ausführungen | Exécutions | Executions

Holz | Bois | Wood



86 Eiche natur, gebürstet, geölt
Chêne naturel, brossé, huilé
Oak natural, brushed, oiled

89 Eiche graphit, gebürstet, geölt
Chêne graphit, brossé, huilé
Oak graphit, brushed, oiled

91 Eiche cognac, gebürstet, geölt
Chêne cognac, brossé, huilé
Oak cognac, brushed, oiled

Füsse | Pieds | Feet

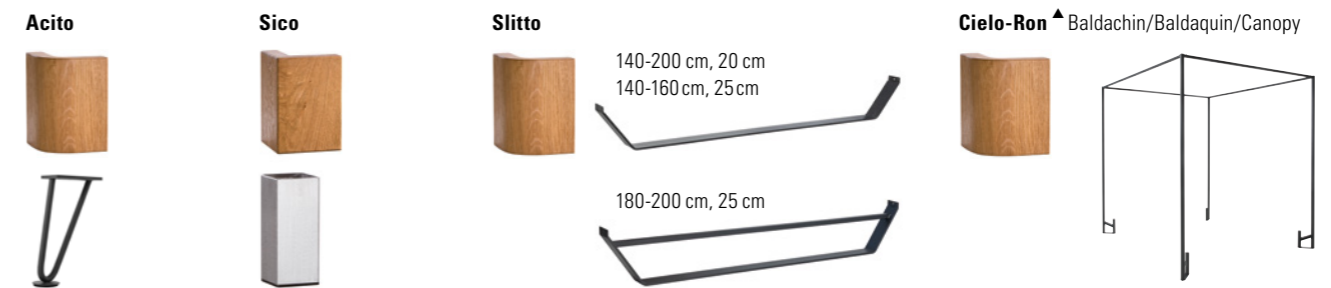
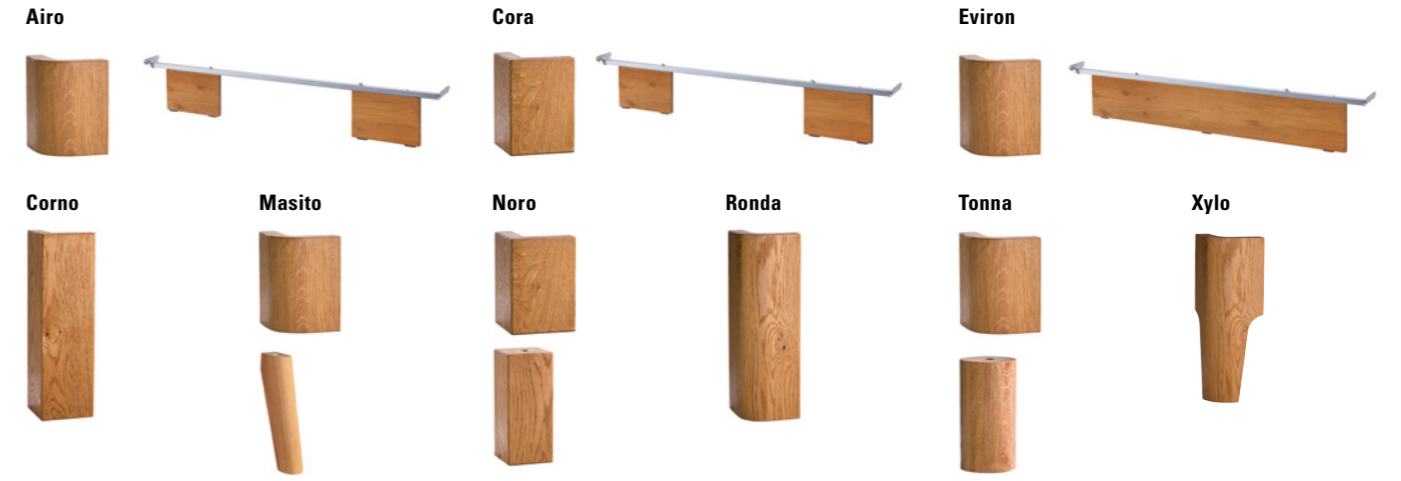

Lovie-Ron Box
90–140 (1 Schublade/Tiroir/Drawer)
140–200 (2 Schubladen/Tiroirs/Drawers)



Holz | Bois | Wood

	Breiten cm Largeurs cm Widths cm	Höhen cm Hauteurs cm Heights cm			Holzfarben Couleurs bois Colours wood				
		20	25	30	10	16	86	89	91
Airo	90–200	●	●	●	●	●	●	●	●
Cora	90–200	●	●	●	●	●	●	●	●
Corno		●	●	●	●	●	●	●	●
Eviron	90–200	●	●	●	●	●	●	●	●
Lovie-Ron Box (1 Schublade/Tiroir/Drawer)	90–140	●	●	●	●	●	●	●	●
Lovie-Ron Box (2 Schubladen/Tiroirs/Drawers)	140–200	●	●	●	●	●	●	●	●
Masito		●	●	●	●	●	●	●	●
Noro		●	●	●	●	●	●	●	●
Practico-Ron Box*	90–200	●	●	●	●	●	●	●	●
Ronda		●	●	●	●	●	●	●	●
Tonna		●	●	●	●	●	●	●	●
Xylo		●	●	●	●	●	●	●	●

Metall | Métal | Metal

	Breiten cm Largeurs cm Widths cm	Höhen cm Hauteurs cm Heights cm			Metallfarben Couleurs métal Colours metal			
		20	25	30	10	16	42	43
Acito		●	●	●	●	●	●	●
Cielo-Ron [▲]	120–200	●	●	●	●	●	●	●
Sico		●	●	●	●	●	●	●
Slitto	140–200	●	●	●	●	●	●	●

[▲] **Curty Vorhang und Vela Baldachin-Tuch siehe Gesamtkatalog Register 2, Seite 2.7** | Curty rideau et Vela tissu de baldachin voir catalogue général registre 2, page 2.7 | Curty curtain and Vela canopy cloth see general catalogue index 2, page 2.7

Eckfüsse/Eckteile + Füße (inkl. Beschläge) | Pieds d'angles/Pièces d'angles + Pieds (Visserie incl.) | Corner feet, Corner pieces + Feet (Fittings included)

*weiss/anthrazit = MDF
*blanc/anthracite = MDF
*white/anthracite = MDF

Metall | Métal | Metal



10 Weiss | Blanc | White **16 Anthracit** **42 Alu** **43 Inox**

Kopfteile | Têtes de lit | Headboards

Alpa



Dimension: 140, 160, 180, 200

Soleo



Dimension: 140, 160, 180, 200

Lisio



Dimension: 90/100, 120, 140, 160, 180, 200

Varus



Dimension: 90/100, 120, 140, 160, 180, 200

gepolstert | rembourrées | upholstered

Cemoa

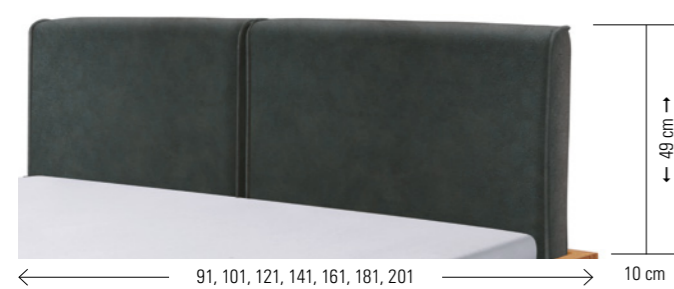

Dimension: 90, 100, 120, 140, 160, 180, 200 (90-120 = 1 Kissen | Coussin | Cushion)

Gewünschte Liegefläche (Länge) = zu bestellende Bettrahmenlänge
 Surface de couchage souhaitée (Longueur) = longueur de cadre de lit à commander
 Desired mattress lying area (Length) = length of bedframe to be ordered
190 = 200
200 = 210
210 = 220

Nur montierbar mit runden Ecken. | Montage uniquement possible avec des angles ronds. | Can only be assembled with round edges. (Füsse | Pieds | Feet: Airo, Eviron, Masito, Practico-Ron Box, Ronda, Slitto, Tonna, Xylo, Cielo-Ron, Lovie-Ron Box).

Das Kopfteil Cemoa enthält in Echtleder keine Teilungsnähte.
 En cuir véritable, la tête de lit Cemoa ne comporte pas de coutures de séparation.
 The Cemoa headboard contains no dividing seams in genuine leather.

Adapter | Adaptateur | Adapter

Bei hohen Matratzen kann mit dem Verlängerungsadapter das Kopfteil um 9 oder 13 cm erhöht werden.

La tête de lit peut être rehaussée de 9 ou 13 cm avec l'adaptateur lorsque le matelas est plus épais. With the extension adapter the headboard can be extended 9 or 13 cm if mattresses are high.

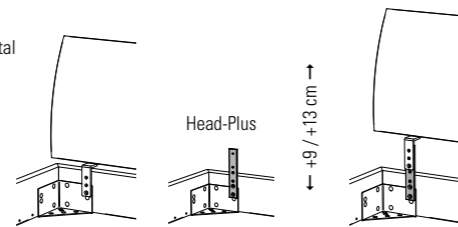
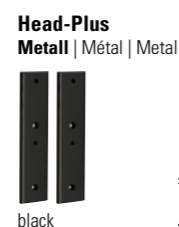

Kissen zu Kopfteilen | Coussins pour têtes de lit | Cushions for headboards

Arona + Alpa



Ravo + Varus



Suny + Varus



Befestigung mit 2 Bändern (Klettverschluss)

Fixation avec 2 bandes Velcro®
 Fixation with 2 ribbons (Velcro® fastener)

Lumo + Alpa



Sano + Alpa



Varo + Varus



Kissen | Coussins | Cushions

	Effektive Masse cm Dimensions effectives cm Effective dimensions cm	zu Kopfteilen pour têtes de lit for headboards		Breitenmasse cm Dimensions de largeur cm Widths dimensions cm
		Alpa	Varus	
Arona	86, 116, 136, 156, 176×3,5×25	●		140, 160, 180/200
Lumo	86, 116, 136, 156, 176×6×25	●		140, 160, 180/200
Ravo	80, 110, 130, 150, 170, 190×3,5×35	●	●	90/100, 120, 140, 160, 180, 200
Sano (2er Set set de 2 set of 2)	55×4×35	●		
Suny (2er Set set de 2 set of 2)	55×6×40	●	●	
Varo (2er Set set de 2 set of 2)	55×10×35		●	

Alle Kissen in Echtleder haben Zier- sowie Teilungsnähte. Ausnahmen: Ravo, Suny und Varo, diese Kissen haben lediglich Ziernähte. | Tous les coussins en cuir véritable ont des coutures décoratives et des coutures de séparation. A l'exception des coussins : Ravo, Suny et Varo, ces coussins ont uniquement des coutures décoratives. | All cushions in genuine leather have decorative and dividing seams. Exceptions: Ravo, Suny and Varo, these cushions only have decorative seams.

Ausführungen | Exécutions | Executions

Holz | Bois | Wood



86 Eiche natur, gebürstet, geölt

Chêne naturel, brossé, huilé
 Oak natural, brushed, oiled

89 Eiche graphit, gebürstet, geölt

Chêne graphit, brossé, huilé
 Oak graphit, brushed, oiled

91 Eiche cognac, gebürstet, geölt

Chêne cognac, brossé, huilé
 Oak cognac, brushed, oiled

selezione

01

MODELLAUSWAHL

Sélection du modèle | Model selection

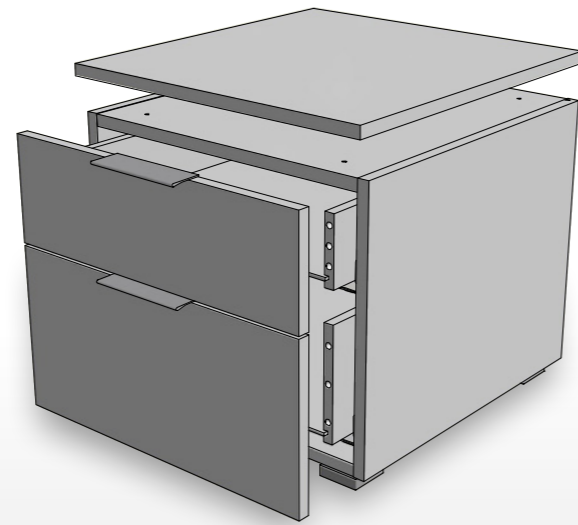

02

KORPUS

Caisson | Body



03

TOP/FRONT

Farben | Couleurs | Colours

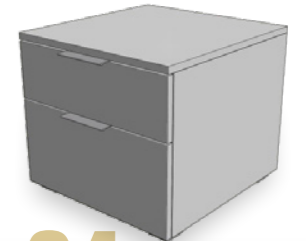

04

GRIFFE

Poignées | Handles

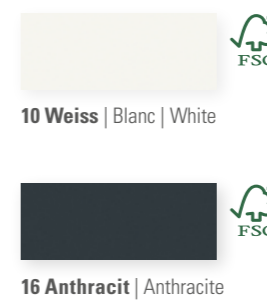
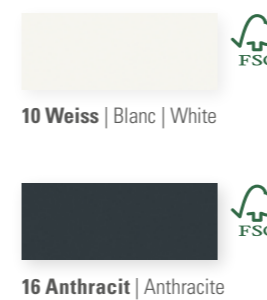
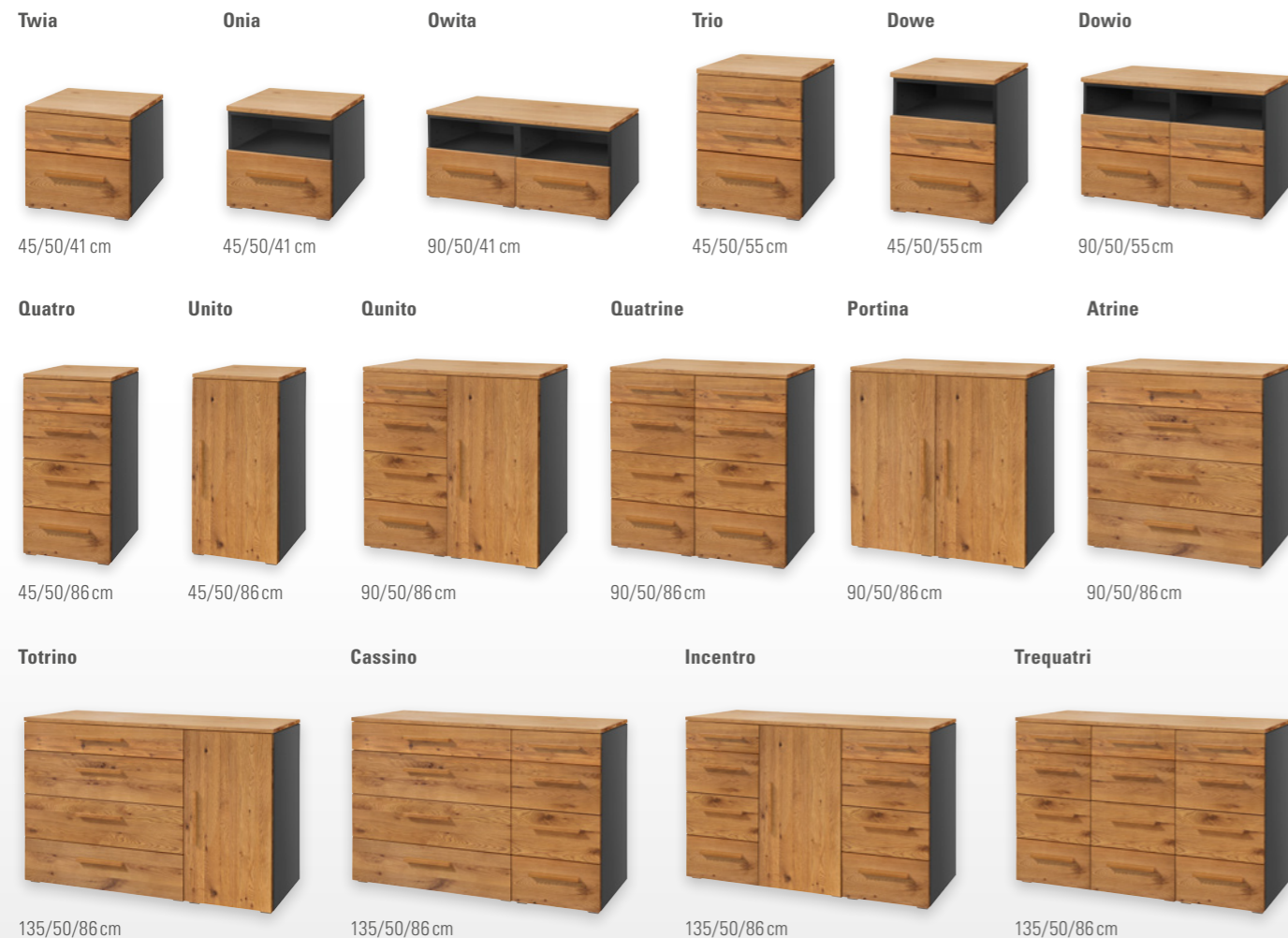

STANDARD



OPTION

Leg 8 cm Jone 10 cm Cila 10 cm

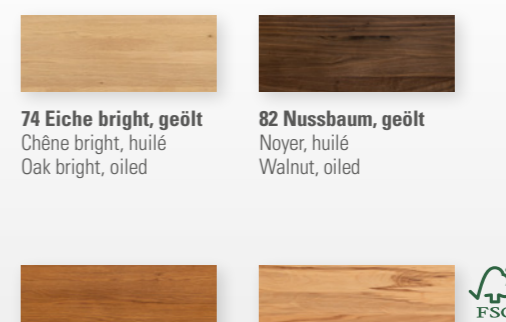

74 Eiche bright, geölt
Chêne bright, huilé
Oak bright, oiled

82 Nussbaum, geölt
Noyer, huilé
Walnut, oiled



80 Kernbuche natur, geölt
Hêtre coeur rouge
naturel, huilé
Heart beech natural, oiled

99 Wildeiche natur, geölt
Chêne nouveau naturel, huilé
Wildoak natural, oiled

STANDARD



Alu
Griff zu Folienfronten
Poignée pour façades en mélaminé
Handle for foil fronts

STANDARD



Holzgriff zu Holzfronten
Poignée en bois pour façades en bois
Wooden handle for wooden fronts

OPTION

Rivo



Used

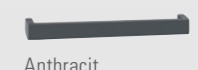

Anthracit

Metallgriff zu Holzfronten

Poignée en métal pour façades en bois
Metal handle for wooden fronts

Stellen Sie sich Ihr Wunsch-Beimöbel nach Ihrem Geschmack zusammen: Der Korpus (Abb. 02), in zwei verschiedenen Farbvarianten, lässt sich zu den Front- und Top-Covern (Abb. 03) in acht Holz- und Farbausführungen kombinieren. Die Beimöbel können zerlegt oder teilmontiert bestellt werden. Bei zusammengesetzten Möbeln (z. B. Qunito, Incentro, ...) muss der Deckel noch montiert werden. Bei Kommoden mit Türen ist jeweils ein Einlegeboden vorhanden, Türöffnung nach links oder rechts möglich. Zusätzliche Böden sind erhältlich.

Composez le meuble d'appoint de vos rêves selon vos goûts : Le caisson (ill. 02), disponible en 2 variantes de couleurs, peut être combiné avec les façades et couvercles supérieurs (ill. 03) en 8 finitions de bois et de coloris. Les meubles d'appoint peuvent être commandés en kits ou assemblés. Pour les meubles assemblés (p. ex. Qunito, Incentro, ...) le couvercle doit encore être fixé. Les commodes avec portes sont équipées d'une étagère, ouverture de la porte possible à gauche ou à droite. Si besoin, des étagères supplémentaires sont disponibles.

Put together the side furniture you want according to your own taste: The body (fig. 02), in two different colour versions, can be combined with the front and top covers (fig. 03) in eight wood and colour versions. The furniture can be ordered disassembled or assembled. For assembled furniture (e.g. Qunito, Incentro, ...) the top cover must still be fitted. Chests of drawers with doors have one shelf, door opening possible to the left or right. Additional shelves are available.



Kombinationsbeispiele
und techn. Informationen
Exemples et informations
Examples and informations





Dimension cm

Totrino	Kommode	Commode	Chest of drawers	135/50/86
Twia	Nachttisch	Table de nuit	Bedside table	45/50/41
Sola	Bank	Table de nuit	Bedside table	140/37/38
Vano	Kissen, Campos blanc 372	Coussin, Campos blanc 372	Cushion, Campos blanc 372	136/34/3

Dimension cm

Modul 18	Rahmen Breiten Längen	Cadre Largeurs Longueurs	Frame Widths Lengths	140, 160, 180, 200 190, 200, 210, 220
Masito	Füße, Eckteile Höhen	Pieds, Pièces d'angles Hauteurs	Feet, Corner pieces Heights	20, 25
Soleo	Kopfteil	Tête de lit	Headboard	140, 160, 180, 200

Alle Holzteile in Eiche cognac, gebürstet, geölt und weiss | Toutes les parties en bois en chêne cognac, brossé, huilé et blanc | All wooden parts in oak cognac, brushed, oiled and white

Weitere Beimöbel siehe Gesamtkatalog Register 2 | Autres accessoires voir catalogue général registre 2 | Further accessories see general catalogue index 2

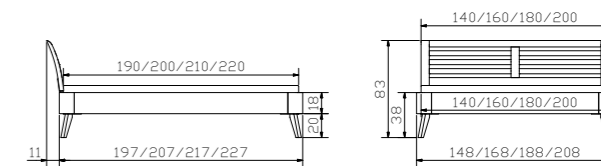



Dimension cm

Modul 18	Rahmen Breiten Längen	Cadre Largeurs Longueurs	Frame Widths Lengths	90, 100, 120, 140, 160, 180, 200 190, 200, 210, 220
Xylo	Eckfüsse Höhen	Pieds d'angles Hauteurs	Corner feet Heights	20(38), 25(43), 30(48)
Gabo	Kopfteil, Campos blanc 372 siehe Gesamtkatalog Register 1	Tête de lit, Campos blanc 372 voir catalogue général registre 1	Headboard, Campos blanc 372 see general catalogue index 1	90, 100, 120, 140, 160, 180, 200

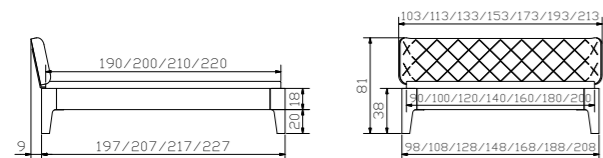

Alle Holzteile in Eiche natur, gebürstet, geölt
 Toutes les parties en bois en chêne naturel, brossé, huilé
 All wooden parts in oak natural, brushed, oiled
Weitere Beimöbel siehe Gesamtkatalog Register 2
 Autres accessoires voir catalogue général registre 2
 Further accessories see general catalogue index 2

Dimension cm

Modul 18	Rahmen Breiten Längen	Cadre Largeurs Longueurs	Frame Widths Lengths	90, 100, 120, 140, 160, 180, 200 190, 200, 210, 220
Xylo	Eckfüsse Höhen	Pieds d'angles Hauteurs	Corner feet Heights	20(38), 25(43), 30(48)
Lisio	Kopfteil	Tête de lit	Headboard	90/100, 120, 140, 160, 180, 200
Koro	Nachttisch	Table de nuit	Bedside table	50/40/57

Alle Holzteile in Eiche cognac, gebürstet, geölt
 Toutes les parties en bois en chêne cognac, brossé, huilé
 All wooden parts in oak cognac, brushed, oiled
Weitere Beimöbel siehe Gesamtkatalog Register 2
 Autres accessoires voir catalogue général registre 2
 Further accessories see general catalogue index 2

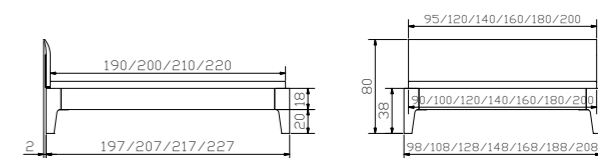



Dimension cm

Sola	Bank	Banquette	Bench	140/37/38
Topia	Kissen, Campos blanc 372	Coussin, Campos blanc 372	Cushion, Campos blanc 372	140/37/10
Cara	Nachttisch	Table de nuit	Bedside table	50/40/40
Vela	Baldachin-Tuch, Baumwolle weiss	Tissu de baldaquin, Coton blanc	Canopy cloth, Cotton white	
	Breiten	Largeurs	Widths	120, 140, 160, 180, 200
	Länge	Longueur	Length	200
Curty	Baldachin-Vorhang (3er Set) Baumwolle weiss	Rideau de baldaquin (set de 3) Coton blanc	Curtain of canopy (set of 3) Cotton white	272/185 (3x)

Dimension cm

Modul 18	Rahmen	Cadre	Frame	
	Breiten	Largeurs	Widths	120, 140, 160, 180, 200
	Längen	Longueurs	Lengths	190, 200, 210, 220
Cielo-Ron white	Baldachin	Baldaquin	Canopy	
	Breiten	Largeurs	Widths	120, 140, 160, 180, 200
	Längen	Longueurs	Lengths	200, 210, 220
	Höhe	Hauteur	Height	20
Ripo	Kopfteil, Campos blanc 372	Tête de lit, Campos blanc 372	Headboard, Campos blanc 372	120, 140, 160, 180, 200

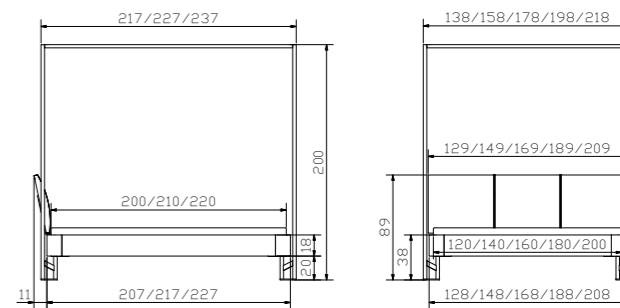

Alle Holzteile in Eiche natur, gebürstet, geölt
 Toutes les parties en bois en chêne naturel, brossé, huilé
 All wooden parts in oak natural, brushed, oiled

Weitere Beimöbel siehe Gesamtkatalog Register 2
 Autres accessoires voir catalogue général registre 2
 Further accessories see general catalogue index 2



				Dimension cm
Cemoa	Kopfteil, Fusio shell 750 hat Einfluss auf Bettlänge siehe Seite 10.6	Tête de lit, Fusio shell 750 a un impact sur la longueur du lit voir page 10.6	Headboard, Fusio shell 750 affects the length of bed see 10.6	90, 100, 120, 140, 160, 180, 200 90 – 120 = 1 Kissen/Coussin/ Cushion
Boga	Kopfteil, Fusio shell 750 siehe Gesamtkatalog Register 1	Tête de lit, Fusio shell 750 voir catalogue général registre 1	Headboard, Fusio shell 750 see general catalogue index 1	90, 100, 120, 140, 160, 180, 200

				Dimension cm
Modul 18	Rahmen Breiten Längen	Cadre Largeurs Longueurs	Frame Widths Lengths	90, 100, 120, 140, 160, 180, 200 190(200), 200(210), 210(220)
Slitto white	Kufen, Eckteile Breiten Höhen	Patins, Pièces d'angles Largeurs Hauteurs	Vats, Corner pieces Widths Heights	140, 160, 180, 200 20, 25
Cemoa	Kopfteil, Campos blanc 372 hat Einfluss auf Bettlänge siehe Seite 8	Tête de lit, Campos blanc 372 a un impact sur la longueur du lit voir page 8	Headboard, Campos blanc 372 affects the length of bed see page 8	90, 100, 120, 140, 160, 180, 200 90 – 120 = 1 Kissen/Coussin/ Cushion
Aida	Kommode	Commode	Chest of drawers	105/40/75
Cara	Nachttisch	Table de nuit	Bedside table	50/40/40

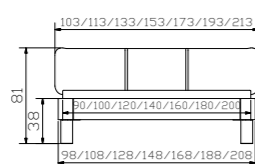
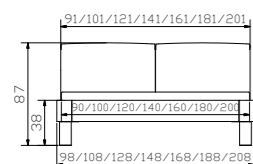

Alle Holzteile in Eiche natur, gebürstet, geölt
Toutes les parties en bois en chêne naturel, brossé, huilé
All wooden parts in oak natural, brushed, oiled

Weitere Beimöbel siehe Gesamtkatalog Register 2
Autres accessoires voir catalogue général registre 2
Further accessories see general catalogue index 2

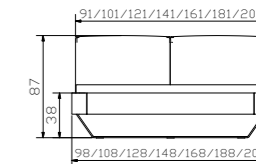
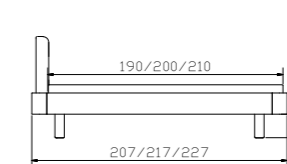



Lovie-Ron Box		Dimension cm	
1 Bettkasten	1 Tiroir de lit	1 Bed drawer	
Breiten	Largeurs	Widths	90, 100, 120, 140
2 Bettkästen	2 Tiroirs de lit	2 Bed drawers	
Breiten	Largeurs	Widths	140, 160, 180, 200
Höhe	Hauteur	Height	25

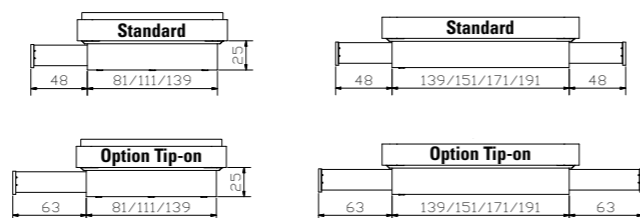

Modul 18		Dimension cm	
Rahmen	Cadre	Frame	
Breiten	Largeurs	Widths	140, 160, 180, 200
Längen	Longueurs	Lengths	190, 200, 210, 220
Slitto anthracit	Kufen, Eckteile	Patins, Pièces d'angles	Vats, corner pieces
Breiten	Largeurs	Largeurs	Widths
Höhen	Höhen	Hauteurs	Heights
			140, 160, 180, 200
			20, 25
Cussina	Kopfteil, Fusio musk 752	Tête de lit, Fusio musk 752	Headboard, Fusio musk 752
	siehe Gesamtkatalog Register 1	voir catalogue général registre 1	see general catalogue index 1
Topa anthracit	Bank inkl. Kissen	Banquette, Coussin incl.	Bench, cushion incl.
	Fusio musk 752	Fusio musk 752	Fusio musk 752
			144/44/38
Caja	Nachttisch	Table de nuit	Bedside table
			48/41/16

Alle Holzteile in Eiche graphit, gebürstet, geölt
 Toutes les parties en bois en chêne graphit, brossé, huilé
 All wooden parts in oak graphit, brushed, oiled

Weitere Beimöbel siehe Gesamtkatalog Register 2
 Autres accessoires voir catalogue général registre 2
 Further accessories see general catalogue index 2

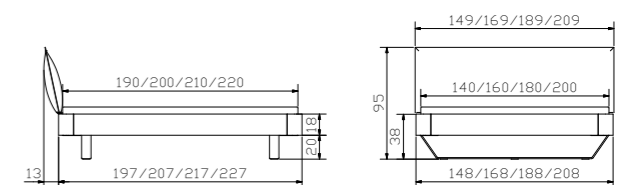

OAK BIANCO

EICHE MASSIV | CHÊNE MASSIF | SOLID OAK



Bettrahmen | Cadre de lit | Bedframe

Modul 18

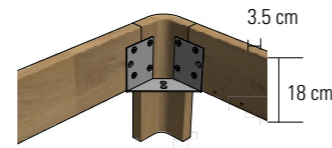

Breiten | Largeurs | Widths:
90, 100, 120, 140, 160, 180, 200 cm

Längen | Longueurs | Lengths:
190, 200, 210, 220 cm

Einlegetiefe | Hauteur encastrable | Insertion depth:
18 cm

Traversen | Traverses | Bars

Wir empfehlen grundsätzlich den Einsatz von Crosstraver (Quertraverse) oder Midtraver (Längstraverse).

Nous recommandons en général l'utilisation de Crosstraver (traverse transversale) ou Midtraver (traverse centrale).
We recommend basically the insertion of Crosstraver (central cross bar) or Midtraver (central bar).

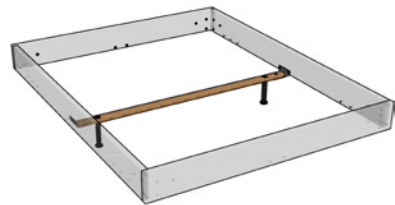

Crosstraver

Quertraverse | Traverse transversale | Central cross bar

Für alle Bettbreiten | Pour toutes les largeurs de lit | For all bed widths

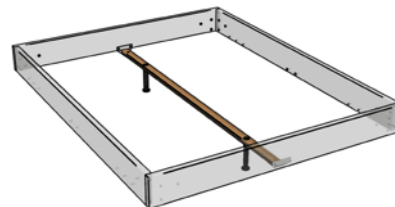

Midtraver

Längstraverse | Traverse centrale | Central bar

Für Betten ab Breite 140 cm mit 2 Lattenrosten oder Motorrahmen-einbau | Pour les lits à partir de 140 cm de largeur avec 2 sommiers ou l'installation d'un cadre motorisé | For beds from 140 cm width with 2 slats or motor frame installation

Übersicht Kompatibilität Traversen siehe Gesamtkatalog Seite 2.12 | Aperçu compatibilité traverses voir catalogue général page 2.12 | Overview compatibility bars see general catalogue page 2.12

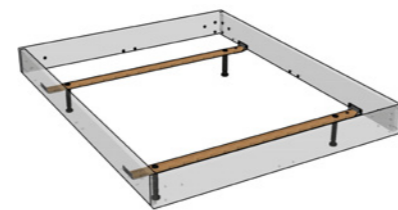

Crosstraver-Twin

Quertraversen | Traverses transversales | Cross bars

Für alle Bettbreiten | Pour toutes les largeurs de lit | For all bed widths

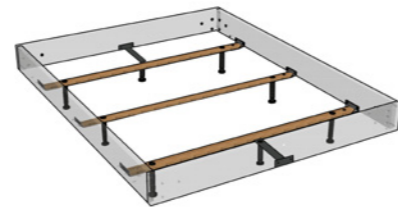

Crosstraver-XXL

Quertraversen | Traverses transversales | Cross bars

Für alle Bettbreiten | Pour toutes les largeurs de lit | For all bed widths

Ausführungen | Exécutions | Executions

Holz | Bois | Wood



73
Eiche bianco, gebürstet, geölt
Chêne bianco, brossé, huilé
Oak bianco, brushed, oiled

Füsse | Pieds | Feet

Airo



Eviron



Slitto



Masito



Jenito



Xylo



Ronda



Skido



Cielo-Ron

Baldachin/Baldaqin/Canopy



Lovie-Ron Box

90-140 (1 Schublade/Tiroir/Drawer)
140-200 (2 Schubladen/Tiroirs/Drawers)



Practico-Ron Box



Eckfüsse/Eckteile + Füße (inkl. Beschläge)

Pieds d'angles/Pièces d'angles + Pieds (Visserie incl.)
Corner feet/Corner pieces + Feet (Fittings included)

	Breiten cm Largeurs cm Widths cm	Höhen cm Hauteurs cm Heights cm			Holzfarben Couleurs bois Colours wood			Metallfarben Couleurs métal Colours metal			
		20	25	30	10	16	73	04	10	16	42
Airo	90-200	●					●				
Cielo-Ron [▲]	120-200	●					●		●		
Eviron	90-200		●				●				
Lovie-Ron Box (1 Schublade/tiroir/drawer)	90-140		●				●				
Lovie-Ron Box (2 Schubladen/tiroirs/drawers)	140-200		●				●				
Practico-Ron Box* (inkl. Boden fond inclus bottom included)	90-200		●		●	●	●				
Ronda		●	●	●			●				
Jenito		●	●				●	●			
Masito		●	●				●				
Slitto	140-200	●	●				●		●	●	
Skido			●				●				
Xylo		●	●	●			●				

*weiss/anthrazit = MDF | *blanc/anthracite = MDF | *white/anthracite = MDF

[▲]Curty Vorhang und Vela Baldachin-Tuch siehe Gesamtkatalog Register 2, Seite 2.7 | Curty rideau et Vela tissu de baldaquin voir catalogue général registre 2, page 2.7 | Curty curtain and Vela canopy cloth see general catalogue index 2, page 2.7

Ausführungen | Exécutions | Executions

Metall | Métal | Metal

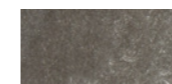

04
used

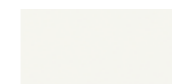

10
white



16
Anthracit



42
Alu

04 Used = Stahl galvanisiert | Acier galvanisé | Steel galvanised
10 White = Stahl pulverbeschichtet | Acier thermolaqué | Steel powder-coated
16 Anthracit = Stahl pulverbeschichtet | Acier thermolaqué | Steel powder-coated
42 Alu = Stahl pulverbeschichtet | Acier thermolaqué | Steel powder-coated

Kopfteile | Têtes de lit | Headboards



Dimension: 90/100, 120, 140, 160, 180, 200



Dimension: 140, 160, 180, 200



Dimension: 90/100, 120, 140, 160, 180, 200

gepolstert | rembourrées | upholstered

*Cemoa



Dimension: 90, 100, 120, 140, 160, 180, 200 (90–120 = 1 Kissen | Coussin | Cushion)

Gewünschte Liegefläche (Länge) = zu bestellende Bettrahmenlänge
 Surface de couchage souhaitée (Longueur) = longueur de cadre de lit à commander
 Desired mattress lying area (Length) = length of bedframe to be ordered

190	= 200
200	= 210
210	= 220

***Nur montierbar mit runden Ecken.** | Montage uniquement possible avec des angles ronds. | Can only be assembled with round edges.
 (Füsse | Pieds | Feet: Airo, Eviron, Masito, Jenito, Practico-Ron Box, Ronda, Slitto, Tonna, Xylo, Cielo-Ron, Lovie-Ron Box).

Das Kopfteil Cemoa enthält in Echtleder keine Teilungsnähte.
 En cuir véritable, la tête de lit Cemoa ne comporte pas de coutures de séparation.
 The Cemoa headboard contains no dividing seams in genuine leather.

Adapter | Adaptateur | Adapter

Bei hohen Matratzen kann mit dem Verlängerungsadapter das Kopfteil um 9 oder 13 cm erhöht werden.

La tête de lit peut être rehaussée de 9 ou 13 cm avec l'adaptateur lorsque le matelas est plus épais.
 With the extension adapter the headboard can be extended 9 or 13 cm if mattresses are high.

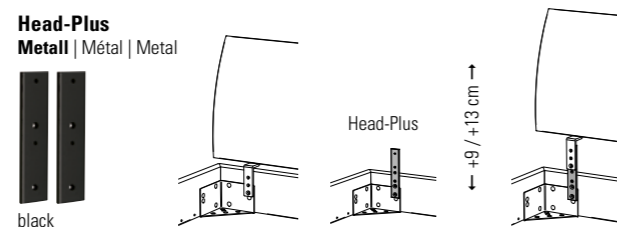

Kissen zu Kopfteilen | Coussins pour têtes de lit | Cushions for headboards



Befestigung mit 2 Bändern (Klettverschluss)
 Fixation avec 2 bandes (velcro®)
 Fixation with 2 ribbons (Velcro® fastener)



Kissen | Coussins | Cushions

	Effektive Masse cm Dimensions effectives cm Effective dimensions cm	zu Kopfteilen pour têtes de lit for headboards		Breitenmasse cm Dimensions de largeur cm Widths dimensions cm
		Alpa	Varus	
Arona	86, 116, 136, 156, 176×3,5×25	●		90/100, 120, 140, 160, 180/200
Lumo	86, 116, 136, 156, 176×6×25	●		90/100, 120, 140, 160, 180/200
Ravo	80, 110, 130, 150, 170, 190×3,5×35	●	●	90/100, 120, 140, 160, 180, 200
Sano (2er Set set de 2 set of 2)	55×4×35	●		
Suny (2er Set set de 2 set of 2)	55×6×40	●	●	
Varo (2er Set set de 2 set of 2)	55×10×35		●	

Alle Kissen in Echtleder haben Zier- sowie Teilungsnähte. Ausnahmen: Ravo, Suny und Varo, diese Kissen haben lediglich Ziernähte. | Tous les coussins en cuir véritable ont des coutures décoratives et des coutures de séparation. A l'exception des coussins : Ravo, Suny et Varo, ces coussins ont uniquement des coutures décoratives. | All cushions in genuine leather have decorative and dividing seams. Exceptions: Ravo, Suny and Varo, these cushions only have decorative seams.



Gepolsterte Kopfteile, Wandpaneele, Stoffauswahl/Farben siehe Gesamtkatalog Register 1, Leselampen siehe Gesamtkatalog Register 2.

Têtes de lits rembourrées, panneaux muraux, choix de tissus/couleurs voir catalogue général registre 1, lampes de lecture voir registre 2.
 Upholstered headboards, wallpanels, choice of tissues/colours see general catalogue index 1, reading lamps see general index 2.



				Dimension cm
Portina	Kommode	Commode	Chest of drawers	90/50/96
Dowe	Nachttisch	Table de nuit	Bedside table	45/50/55
Sola	Bank	Banquette	Bench	140/37/38
Claudio alu	Herrendiener	Valet	Dressboy	45/28/107

				Dimension cm
Modul 18	Rahmen Breiten Längen	Cadre Largeurs Longueurs	Frame Widths Lengths	140, 160, 180, 200 190, 200, 210, 220
Skido	Kufen, Eckteile Breiten Höhe	Patins, Pièces d'angles Largeurs Hauteur	Vats, Corner pieces Widths Height	140, 160, 180, 200 25
Varus	Kopfteil	Tête de lit	Headboard	140, 160, 180, 200
Ravo	Kissen, Boucle mouse 773	Coussin, Boucle mouse 773	Cushion, Boucle mouse 773	140, 160, 180, 200

Alle Holzteile in Eiche bianco, gebürstet, geölt | Toutes les parties en bois en chêne bianco, brossé, huilé | All wooden parts in oak bianco, brushed, oiled
Portina, Dowe: Eiche bright, geölt und anthracite | Chêne bright, huilé et anthracite | Oak bright, oiled and anthracite
Weitere Beimöbel siehe Gesamtkatalog Register 2 | Autres accessoires voir catalogue général registre 2 | Further accessories see general catalogue index 2

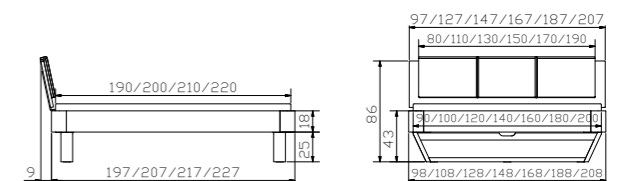



Dimension cm

Atrine	Kommode siehe Gesamtkatalog Register 2	Commode voir catalogue général registre 2	Chest of drawers see general catalogue index 2	90/50/86
Onia	Nachttisch siehe Gesamtkatalog Register 2	Table de nuit voir catalogue général registre 2	Bedside table see general catalogue index 2	45/50/41
Sola	Bank	Banquette	Bench	140/37/38
Topia	Kissen, Fusio shell 750	Coussin, Fusio shell 750	Cushion, Fusio shell 750	

Dimension cm

Modul 18	Rahmen Breiten Längen	Cadre Largeurs Longueurs	Frame Widths Lengths	90, 100, 120, 140, 160, 180, 200 190, 200, 210, 220
Xylo	Eckfüsse Höhen	Pieds d'angles Hauteurs	Corner feet Heights	20(38), 25(43), 30(48)
Elipsa	Kopfteil, Fusio shell 750 siehe Gesamtkatalog Register 1	Tête de lit, Fusio shell 750 voir catalogue général registre 1	Headboard, Fusio shell 750 see general catalogue index 1	90, 100, 120, 140, 160, 180, 200

Alle Holzteile in Eiche bianco, gebürstet, geölt oder Eiche bright, geölt | Toutes les parties en bois en chêne bianco, brossé, huilé ou chêne bright, huilé | All wooden parts in oak bianco, brushed, oiled or oak bright, oiled

Atrine, Onia: Eiche bright, geölt und weiss | Chêne bright, huilé et blanc | Oak bright, oiled and white

Weitere Beimöbel siehe Gesamtkatalog Register 2 | Autres accessoires voir catalogue général registre 2 | Further accessories see general catalogue index 2

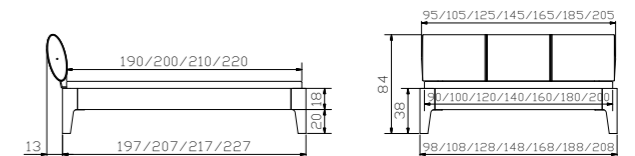



MOVIE-/TOP LINE



FACTORY LINE



WOOD LINE



LOUNGE



FINE LINE



NATURO LINE



OAK LINE



OAK WILD



DREAM LINE



**EDITION
BOXSPRING**



**FUNCTION/COMFORT
KIDS & GUESTS**



**LATTENROSTE &
MATRATZEN**



Gesamtkatalog
Catalogue général
General catalogue