



swiss bed concept



HASENA
the dream factory



OAKWILD ASPINO / VINTAGE BORMIO CORTINA

WILDEICHE MASSIV | CHÊNE NOUEUX MASSIF | SOLID WILDOAK



Hasena – mein Bett

Hasena – mon lit | Hasena – my bed

Beständige Passion

Une passion constante
Enduring Passion

Mehr als ein Lebenswerk

Als Familienunternehmen gegründet, überzeugen wir seit über 70 Jahren mit hoher Qualität und Vielseitigkeit im Bereich Schlafzimmernmöbel.

Plus que l'œuvre d'une vie

Fondée en tant qu'entreprise familiale, nous convainquons depuis plus de 70 ans par notre qualité élevée et notre polyvalence dans le domaine des meubles de chambre à coucher.

More than a life's work

Founded as a family business, we have been impressing with high quality and versatility in the field of bedroom furniture for over 70 years.



swiss bed concept



swiss bed concept

Ein cleveres Baukastensystem

Sie wählen Ihren favorisierten Bettrahmen aus und kombinieren dazu Füße und Kopfteil Ihrer Wahl. Dabei können Sie quer durch die Kollektionen auf unterschiedliche Materialien und Farben zugreifen.

Un système modulaire astucieux

Vous choisissez votre cadre de lit préféré et le combinez avec les pieds et les têtes de lit de votre choix. Vous pouvez choisir parmi une variété de matériaux et de couleurs dans toutes les collections.

A clever modular system

You choose your favourite bed frame and combine it with the feet and headboards of your choice. You can choose from a variety of materials and colours throughout the collections.

5 Jahre Garantie

Service de livraison rapide
5 years warranty



Unser Versprechen

Vom Baum zum Bett – mittels handwerklicher Perfektion und hochwertigen Materialien. Sie erhalten 5 Jahre Garantie auf die Material- und Oberflächenbeschaffenheit, sowie die fachgerechte Verarbeitung aller Modelle ab Kaufdatum. Weitere Informationen finden Sie auf unserer Website.

Notre promesse

De l'arbre au lit – grâce à un artisanat parfait et des matériaux de haute qualité. Vous bénéficiez d'une garantie de 5 ans sur la qualité des matériaux et des surfaces, ainsi que sur la fabrication professionnelle de tous les modèles à compter de la date d'achat. Vous trouverez plus d'informations sur notre site Internet.

Our promise

From tree to bed – by means of perfect craftsmanship and high-quality materials. You receive a 5-year guarantee on the material and surface quality, as well as the professional workmanship of all models from the date of purchase. Further information can be found on our website.

Schnelllieferservice

Service de livraison rapide
Quick delivery service



Komfort ohne Wartezeit

Mit unserem Schnelllieferservice «PRONTO» können wir eine grosse Auswahl an Betten mit Beimöbeln und alle Modelle aus Edition pronto, Dream pronto und Boxspring pronto ab Lager liefern.

Le confort sans attente

Notre service de livraison rapide « PRONTO » permet de livrer un large choix de lits, de meubles d'appoint et tous les modèles de l'Édition Pronto, Dream pronto et Boxspring Pronto à partir du stock.

Comfort without waiting

With our quick delivery service «PRONTO» we can offer a large selection of beds with ancillary furniture and all models from models from Edition pronto, Dream pronto and Boxspring pronto from stock.



Vielseitig kombinierbar

Unser ausgeklügeltes Baukastensystem «swiss bed concept» bietet eine riesige Auswahl an Füßen, Kopfteilen und Beimöbeln. Darüber hinaus umfasst es verschiedene Stoff-, Kunstleder- und Lederbezüge sowie diverse Holz- und Metallausführungen. Abgestimmte Lattenroste und Matratzen komplettieren unsere Betten zur Wohlfühloase.

Combinable à versatile

Notre système modulaire sophistiqué «swiss bed concept» propose un choix énorme de pieds, têtes de lits et accessoires. Par ailleurs le comporte différents tissus, cuirs synthétiques et véritables, ainsi que diverses variantes de bois et métal. Des sommiers à lattes et des matelas adaptés complètent nos lits pour un espace bien-être.

Versatile combinable

Our ingenious modular system «swiss bed concept» offers a huge selection of feet, headboards and accessories. In addition, it includes different fabrics, synthetic leather and real leather covers and different wood and metal versions. Matching slatted frames and mattresses complete our beds to an oasis of well-being.

Nachhaltigkeit bei Hasena

Unser wichtigster Lieferant, die Natur, ist sensibel und benötigt lange Regenerationszeiten bei Überbeanspruchung. Wir respektieren die von uns genutzten Ökosysteme und stellen unsere Produkte nachhaltig und mit hohem sozialen Engagement her.



Soziale Verantwortung

Responsabilité sociale
Social responsibility



Holzoberflächen

Surfaces en bois
Wood surfaces



Stabil im Aufbau

Unsere Betten überzeugen durch eine hohe Stabilität. Mittels Einsatz verschiedener Traversen ist eine gesamthafte Belastung von 300 bis 450 kg, inklusive Lattenroste und Matratzen, möglich.

Construction robuste

Nos lits sont convaincants par leur grande stabilité. En utilisant différentes fermes, une charge totale de 300 à 450 kg, y compris les sommiers à lattes et les matelas, est possible.

Solid in construction

Our beds convince with their high stability. By using different trusses, a total load of 300 to 450 kg, including slatted frames and mattresses, is possible.



Einfach in der Montage

Unser Betten-System begeistert durch einen einfachen Aufbau mit leicht verständlicher Montageanleitung sowie hochwertigen Verbindungselementen, welche einen vielfachen Ab- und Wiederaufbau ermöglichen.

Montage facile

Notre système de lits séduit par une installation facile grâce aux instructions de montage bien compréhensibles ainsi que par les éléments de fixation haut de gamme permettant de monter et démonter les lits à de nombreuses reprises.

Solid in construction

Our beds convince with their high stability. By using different trusses, a total load of 300 to 450 kg, including slatted frames and mattresses, is possible.

Durabilité chez Hasena

Notre fournisseur le plus important, la nature, est sensible et nécessite un long temps de régénération en cas de surutilisation. Nous respectons les écosystèmes que nous utilisons et fabriquons nos produits de manière durable et avec un haut niveau d'engagement social.



Holzbeschaffung

Approvisionnement en bois
Wood procurement



Recycelte Stoffe

Tissus recyclés
Recycled fabrics



Produktion Massivholz

Production bois massif
Manufacturing solid wood



Energiegewinnung

Production énergétique
Production of energy



Bettrahmen | Cadre de lit | Bedframe

Cadro 18



Breiten | Largeurs | Widths:
90, 100, 120, 140, 160, 180, 200 cm

Längen | Longueurs | Lengths:
190, 200, 210, 220 cm

Einlegetiefe | Hauteur encastrable | Insertion depth:
18 cm

Cadro 23



Breiten | Largeurs | Widths:
120, 140, 160, 180, 200 cm

Längen | Longueurs | Lengths:
200, 210, 220 cm

Einlegetiefe | Hauteur encastrable | Insertion depth:
18*, 23 cm

Ausführungen | Exécutions | Executions

Holz | Bois | Wood



93 Wildeiche natur, gebürstet, geölt
Chêne nouveau naturel, brossé, huilé
Wildoak natural, brushed, oiled

96 Wildeiche pure, gebürstet, geölt
Chêne nouveau pure, brossé, huilé
Wildoak pure, brushed, oiled

98 Wildeiche coffee, gebürstet, geölt
Chêne nouveau coffee, brossé, huilé
Wildoak coffee, brushed, oiled

*Aosta 16



Breiten | Largeurs | Widths:
140, 160, 180, 200 cm

Längen | Longueurs | Lengths:
200, 210, 220 cm

Einlegetiefe | Hauteur encastrable | Insertion depth:
16 cm

*Pilatus 23



Breiten | Largeurs | Widths:
140, 160, 180, 200 cm

Längen | Longueurs | Lengths:
200, 210, 220 cm

Einlegetiefe | Hauteur encastrable | Insertion depth:
18*, 23 cm

***Aosta 16 und Pilatus 23 nur in Ausführung Wildeiche natur erhältlich.**
Aosta 16 et Pilatus 23 ne sont disponibles qu'en chêne nouveau naturel.
Aosta 16 and Pilatus 23 are only available in Wildoak natural.

Traversen | Traverses | Bars

Wir empfehlen grundsätzlich den Einsatz von Crosstraver (Quertraverse) oder Midtraver (Längstraverse).
Nous recommandons en général l'utilisation de Crosstraver (traverse transversale) ou Midtraver (traverse centrale).
We recommend basically the insertion of Crosstraver (central cross bar) or Midtraver (central bar).

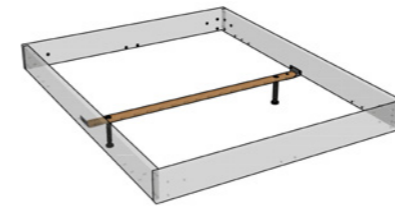

Crosstraver
Quertraverse | Traverse transversale | Central cross bar

Für alle Bettbreiten | Pour toutes les largeurs de lit | For all bed widths

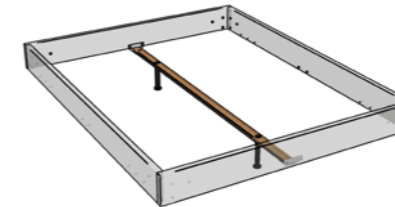

Midtraver
Längstraverse | Traverse centrale | Central bar

Für Betten ab Breite 140 cm mit 2 Lattenrosten oder Motorrahmen-einbau | Pour les lits à partir de 140 cm de largeur avec 2 sommiers ou l'installation d'un cadre motorisé | For beds from 140 cm width with 2 slats or motor frame installation

Übersicht Kompatibilität Traversen siehe Gesamtkatalog Seite 2.12 | Aperçu compatibilité traverses voir catalogue général page 2.12 | Overview compatibility bars see general catalogue page 2.12

* Cadro 23/Pilatus 23

Bei der Einlegetiefe 18 cm sind die Füße/Sockel um 5 cm versenkt und um diese Höhe weniger sichtbar.

Avec les équerres en position haute (18 cm) les pieds/socle sont encastrés de 5 cm sous le cadre et donc moins visibles.

With the insertion depth 18 cm the feet/socket are sunken in by 5 cm and this height less visible.

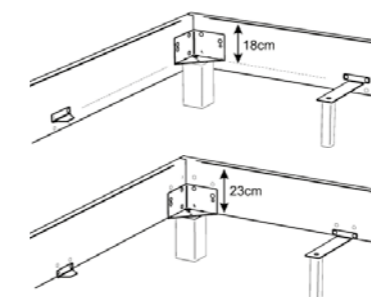

Option Midtraver-move

Achtung: nicht bei Füßen in der Höhe 30 cm, Lovie-Box und Practico-Box einsetzbar

Attention : ne s'applique pas aux pieds à une hauteur de 30 cm, Lovie-Box et Practico-Box

Attention: not applicable for feet at a height of 30 cm, Lovie-Box and Practico-Box

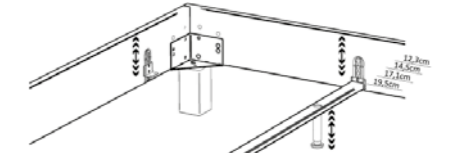

Wild und ungezähmt

Durch die natürlich vorkommenden Äste und Markstrahlen der Wild-Eiche entstehen faszinierende Farb- und Struktur-Differenzen, die unseren massiven Möbelstücken aus der Oak-Wild-Reihe ihren aussergewöhnlich lebendigen Charakter verleihen. Die vielzähligen Füße und Kopfteile eröffnen zudem spannende Kombinationsmöglichkeiten mit unterschiedlichen Materialien.

Eichenholz ist ein Naturmaterial, das im Laufe der Jahre reift und seinen Charakter ändert. Bei der Ausführung Wild wird bewusst mit Rissen und Ästen versehenes Holz verwendet, um den speziellen Wild-Look und Charakter zu erreichen.

Farb- und Struktur-differenzen sind bei Echtholz naturbedingte Eigenschaften.

Sauvage et indompté

Les branches naturelles et les rayons médullaires de chêne sauvage créent des différences de couleur et de structure fascinantes qui confèrent à nos meubles massifs de la gamme Oak-Wild leur caractère extraordinairement vivant. Les nombreux pieds et têtes de lit offrent également des possibilités de combinaison passionnantes avec différents matériaux.

Le bois de chêne est un matériau naturel qui mûrit au fil des ans et change de caractère. La version Wild utilise délibérément du bois avec des fissures et des nœuds pour obtenir l'aspect et le caractère spéciaux Wild.

Les différences de couleur et de structure sont des caractéristiques naturelles du bois véritable.

Wild und untamed

The naturally occurring branches and medullary rays of wild oak create fascinating differences in colour and structure, which give our massive pieces of furniture from the Oak-Wild range their extraordinarily lively character. The numerous feet and headboards also open up exciting combination possibilities with different materials.

Oak wood is a natural material that matures over the years and changes its character. The Wild version deliberately uses wood with cracks and knots to achieve the special Wild look and character.

Colour and structure differences are natural characteristics of real wood.

Füsse | Pieds | Feet

Holz | Bois | Wood



Holz Bois Wood	Masse cm Dimension cm	Breiten cm Largeurs cm Widths cm	Höhen cm Hauteurs cm Heights cm				Holzfarben Couleurs bois Colours wood					Metallfarben Couleurs métal Colours metal	
			10	20	25	30	10	16	93	96	98		
Evio		90-200											
Ivio	10x10												
Leno	6x5,5												
Lovie-Box** (1 Schublade/Tiroir/Drawer)		90-140											
Lovie-Box** (2 Schubladen/Tiroirs/Drawers)		140-200											
Onito iron*	18,5x18,5												
Practico-Box (inkl. Boden fond inclus bottom included)		90-200											
Skid		140-200											
Vilo		90-200											

*nur mit Bettrahmen Cadro 18 und Aosta 16 möglich | uniquement possible avec cadres de lit Cadro 18 et Aosta 16 | only possible with bedframes Cadro 18 and Aosta 16

Bei Cadro 23 und Pilatus 23 (Einlegetiefe 18 cm) sind die Füsse/Sockel um 5 cm versenkt und um diese Höhe weniger sichtbar.
Avec Cadro 23 et Pilatus 23 (hauteur de cadre 18 cm) les pieds/sockle sont encastrés de 5 cm sous le cadre et donc moins visibles.
With Cadro 23 and Pilatus 23 (insertion depth 18 cm) the feet/socket are sunken in by 5 cm and this height less visible.

Holz | Bois | Wood



10 Weiss
Blanc
White

16 Anthracit

93 Wildeiche natur, gebürstet, geölt
Chêne nouveau naturel, brossé, huilé
Wildoak natural, brushed, oiled

96 Wildeiche pure, gebürstet, geölt
Chêne nouveau pure, brossé, huilé
Wildoak pure, brushed, oiled

98 Wildeiche coffee, gebürstet, geölt
Chêne nouveau coffee, brossé, huilé
Wildoak coffee, brushed, oiled

Füsse | Pieds | Feet

Metall | Métal | Metal



Metall Métal Metal	Masse cm Dimension cm	Breiten cm Largeurs cm Widths cm	Höhen cm Hauteurs cm Heights cm				Metallfarben Couleurs métal Colours metal											
			10	20	25	30	00	04	10	16	40	41	42	43	45			
Caro	6x6																	
Cielo**▲		120-200																
Facil																		
Fasio	Ø5/9																	
Indus	6x2	140-200																
Jenio	12x5																	
Mico	8x8																	
Quada	20x6,5																	
Reca	24x12																	
Road*	Ø13																	
Slid	8/1	140-200																
Soko	Ø6																	
Stomp	Ø8																	
Tondo	Ø3,5																	

* Füsse fixiert, Rollen nur optisch | Pieds fixes, roulettes uniquement décoratives | Feet fixed, castors only visual

** Cielo nur mit Rahmen Cadro 18 + 23 möglich | Cielo possible uniquement avec le cadre Cadro 18 + 23 | Cielo only possible with frame Cadro 18 + 23

▲ Curty Vorhang und Vela Baldachin-Tuch siehe Gesamtkatalog Register 2, Seite 2.7 | Curty rideau et Vela tissu de baldaquin voir catalogue général registre 2, page 2.7

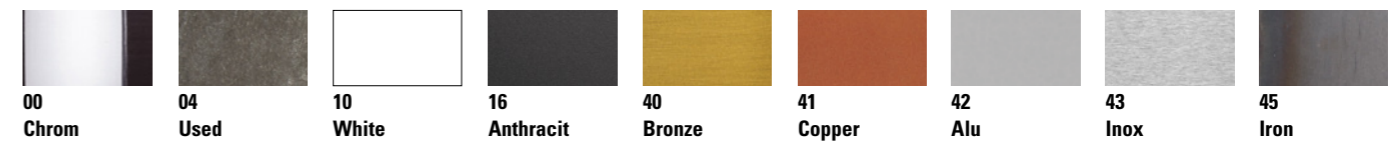

00 Chrom = Edelstahl poliert | Acier poli | Stainless steel polished

04 Used = Stahl galvanisiert | Acier galvanisé | Steel galvanised

10 White = Stahl pulverbeschichtet | Acier thermolaqué | Steel powder-coated

16 Anthracit = Stahl pulverbeschichtet | Acier thermolaqué | Steel powder-coated

40 Bronze = Stahl lackiert | Acier laqué | Steel lacquered

41 Copper = Stahl lackiert | Acier laqué | Steel lacquered

42 Alu = Stahl pulverbeschichtet | Acier thermolaqué | Steel powder-coated

43 Inox = Edelstahl geschliffen | Acier poncé | Stainless steel ground

45 Iron = Stahl geflammt, pulverbeschichtet | Acier flammé, thermolaqué | Steel mottled, powder-coated

Kopfteile | Têtes de lit | Headboards

Alpa



Dimension: 90/100, 120, 140, 160, 180, 200

Bordo



Dimension: 140, 160, 180, 200

Sion



Dimension: 140, 160, 180, 200

Naturo L



Dimension: 140, 160, 180, 200

Balco*



Dimension: 140/160, 180/200

Lisio



Dimension: 90/100, 120, 140, 160, 180, 200

Naturo M



Dimension: 140, 160, 180, 200

Kopfteile | Têtes de lit | Headboards

	Holzfarben Couleurs bois Colours wood		
	93	96	98
Alpa	●	●	●
Balco	●		
Bordo	●	●	
Lisio	●		
Sion	●	●	●
Naturo M	●		
Naturo L	●	●	

*nur mit Bettrahmen Aosta 16 möglich | uniquement possible avec cadre de lit Aosta 16 | only possible with bed frame Aosta 16

Adapter | Adaptateur | Adapter

Bei hohen Matratzen kann mit dem Verlängerungsadapter das Kopfteil erhöht werden.

La tête de lit peut être rehaussée avec l'adaptateur lorsque le matelas est plus épais.
With the extension adapter the headboard can be extended if mattresses are high.

Head-Plus

Metall | Métal | Metal

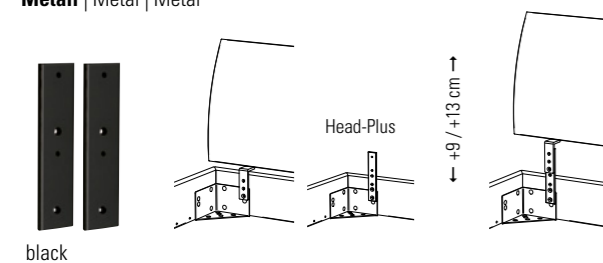

black

Balco-Hold L (Balco)

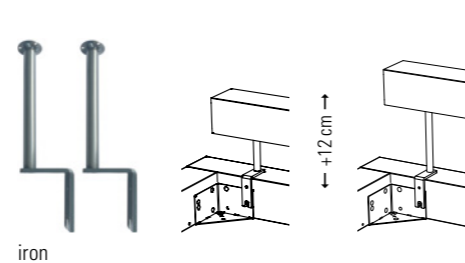

iron

Kissen zu Kopfteilen | Coussins pour têtes de lit | Cushions for headboards

Arona + Alpa



Nakio + Balco



Sano + Sion



Varo + Bordo



Lumo + Alpa



Ravo + Sion



Suny + Alpa



Befestigung mit 2 Bändern (Klettverschluss)

Fixation avec 2 bandes (Velcro®)
Fixation with 2 ribbons (Velcro® fastener)

Alle Kissen in Echtleder haben Zier- sowie Teilungsnähte. Ausnahmen: Nakio, Ravo, Suny und Varo, diese Kissen haben lediglich Ziernähte.

Tous les coussins en cuir véritable ont des coutures décoratives et des coutures de séparation. A l'exception des coussins : Nakio, Ravo, Suny et Varo, ces coussins ont uniquement des coutures décoratives.

All cushions in genuine leather have decorative and dividing seams. Exceptions: Nakio, Ravo, Suny and Varo, these cushions only have decorative seams.

Kissen | Coussins | Cushions

	Effektive Masse cm Dimensions effectives cm Effective dimensions cm
	Arona
Lumo	86, 116, 136, 156, 176×6×25
Nakio (2er Set set de 2 set of 2)	55×18×14
Ravo	80, 110, 130, 150, 170, 190×3,5×35
Sano (2er Set set de 2 set of 2)	55×4×35
Suny (2er Set set de 2 set of 2)	55×6×40
Varo	55×11×35

zu Kopfteilen pour têtes de lit for headboards

	Alpa	Balco	Naturo M/L	Sion	Bordo
Arona	●		●		
Lumo	●		●		
Nakio (2er Set set de 2 set of 2)		●			
Ravo	●			●	●
Sano (2er Set set de 2 set of 2)	●			●	
Suny (2er Set set de 2 set of 2)	●			●	●
Varo					●

Breitenmasse cm Dimensions de largeur cm Widths dimensions cm

90/100, 120, 140, 160, 180/200
90/100, 120, 140, 160, 180/200
90/100, 120, 140, 160, 180, 200

selezione

01

MODELLAUSWAHL

Sélection du modèle | Model selection

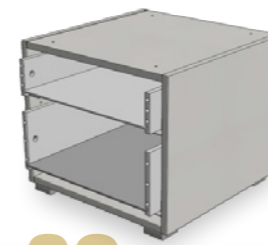
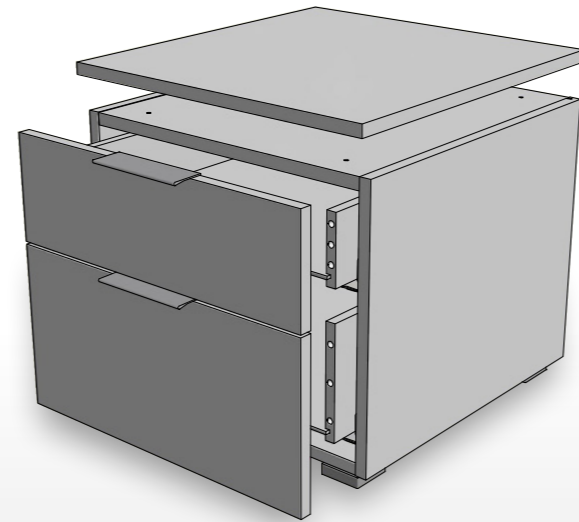

02

KORPUS

Caisson | Body



03

TOP/FRONT

Farben | Couleurs | Colours

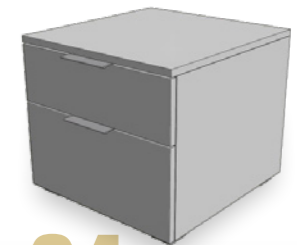

04

GRIFFE

Poignées | Handles

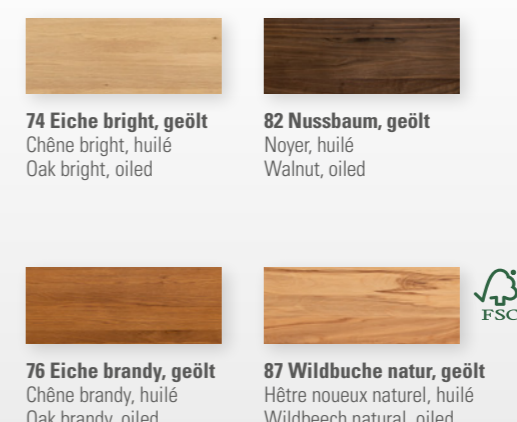
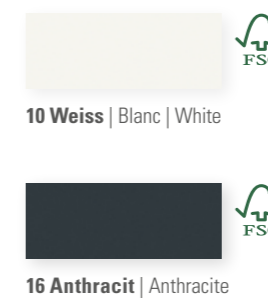
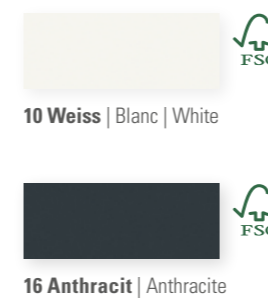
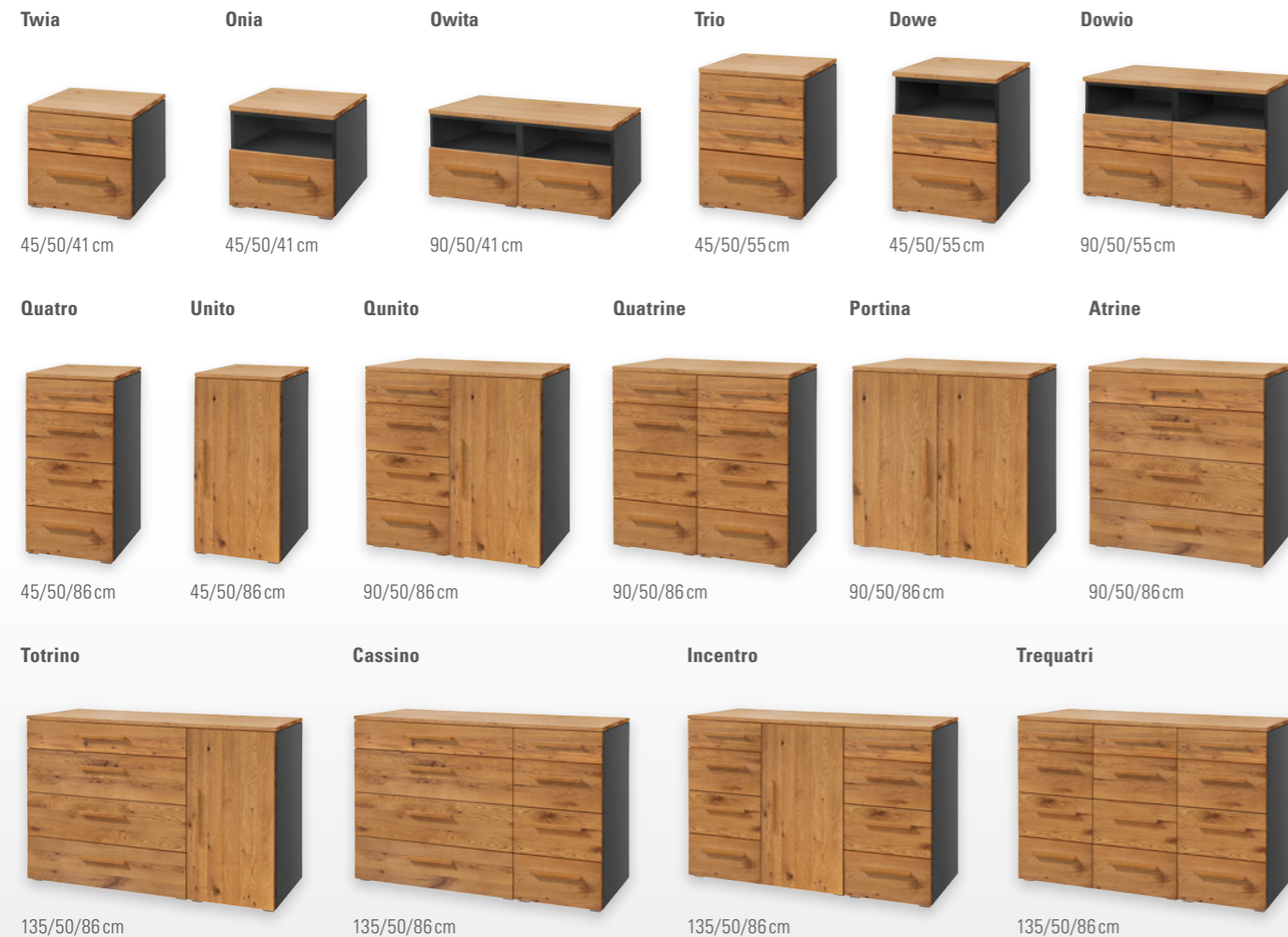

Stellen Sie sich Ihr Wunsch-Beimöbel nach Ihrem Geschmack zusammen: Der Korpus (Abb. 02), in zwei verschiedenen Farbvarianten, lässt sich zu den Front- und Top-Covern (Abb. 03) in acht Holz- und Farbausführungen kombinieren. Die Beimöbel können zerlegt oder teilmontiert bestellt werden. Bei zusammengesetzten Möbeln (z. B. Qunito, Incentro, ...) muss der Deckel noch montiert werden. Bei Kommoden mit Türen ist jeweils ein Einlegeboden vorhanden, Türöffnung nach links oder rechts möglich. Zusätzliche Böden sind erhältlich.

Composez le meuble d'appoint de vos rêves selon vos goûts : Le caisson (ill. 02), disponible en 2 variantes de couleurs, peut être combiné avec les façades et couvercles supérieurs (ill. 03) en 8 finitions de bois et de coloris. Les meubles d'appoint peuvent être commandés en kits ou assemblés. Pour les meubles assemblés (p. ex. Qunito, Incentro, ...) le couvercle doit encore être fixé. Les commodes avec portes sont équipées d'une étagère, ouverture de la porte possible à gauche ou à droite. Si besoin, des étagères supplémentaires sont disponibles.

Put together the side furniture you want according to your own taste: The body (fig. 02), in two different colour versions, can be combined with the front and top covers (fig. 03) in eight wood and colour versions. The furniture can be ordered disassembled or assembled. For assembled furniture (e.g. Qunito, Incentro, ...) the top cover must still be fitted. Chests of drawers with doors have one shelf, door opening possible to the left or right. Additional shelves are available.



Kombinationsbeispiele und techn. Informationen
Exemples et informations
Examples and informations





				Dimension cm
Calmo	Bank	Banquette	Bench	140/37/38
Caja	Nachttisch	Table de nuit	Bedside table	48/41/16
Smart black	Leselampe (2er Set) schwarz 12V DC, 30 LED warm Dreistufenschaltung	Lampe de lecture (set de 2) noir 12V DC, 30 LED warm Interrupteur à 3 crans	Reading lamp (set of 2) black 12V DC, 30 LED warm Three step circuit	

Alle Holzteile in Wildeiche natur, gebürstet, geölt | Toutes les parties en bois en chêne nouveau, brossé, huilé | All wooden parts in wildoak natural, brushed, oiled
Leselampen und weitere Beimöbel siehe Gesamtkatalog Register 2 | Lampes de lecture et autres accessoires voir catalogue général registre 2 | Reading lamps and further accessories see general catalogue index 2

				Dimension cm
Cadro 18	Rahmen Breiten Längen	Cadre Largeurs Longueurs	Frame Widths Lengths	140, 160, 180, 200 190, 200, 210, 220
Skid	Kufen Breiten Höhe	Patins Largeurs Hauteur	Vats Widths Height	140, 160, 180, 200 25
Alpa Ravo	Kopfteil Kissen, Alpina anthrazit 391	Tête de lit Coussin, Alpina anthrazit 391	Headboard Cushion, Alpina anthrazit 391	140, 160, 180, 200 140, 160, 180, 200

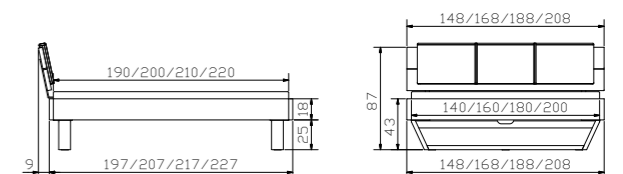



				Dimension cm
Qunito	Kommode	Commode	Chest of drawers	90/50/86
Carpi	Nachttisch höhenverstellbar 34–53 cm	Table de nuit réglable en hauteur 34–53 cm	Bedside table adjustable in height 34–53 cm	52/42/34–53

				Dimension cm
Cadro 18	Rahmen Breiten Längen	Cadre Largeurs Longueurs	Frame Widths Lengths	90, 100, 120, 140, 160, 180, 200 190, 200, 210, 220
Leno	Füße Höhen	Pieds Hauteurs	Feet Heights	20, 25
Boga	Kopfteil, Ranch stone 660 siehe Gesamtkatalog Register 1	Tête de lit, Ranch stone 660 voir catalogue général registre 1	Headboard, Ranch stone 660 see general catalogue index 1	90, 100, 120, 140, 160, 180, 200

Alle Holzteile in Wildeiche natur, gebürstet, geölt | Toutes les parties en bois en chêne nouveau, brossé, huilé | All wooden parts in wildoak natural, brushed, oiled
Qunito: Korpus Anthracit | Caisson anthracite | Body anthracite
Weitere Beimöbel siehe Gesamtkatalog Register 2 | Autres accessoires voir catalogue général registre 2 | Further accessories see general catalogue index 2

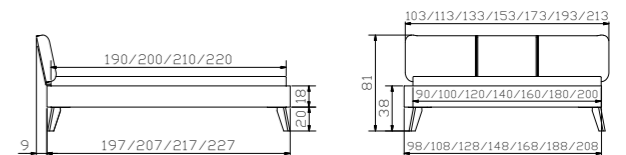



				Dimension cm
Atrine	Kommode	Commode	Chest of drawers	90/50/86
Twia	Nachttisch	Table de nuit	Bedside table	45/50/41

				Dimension cm
Cadro 18	Rahmen Breiten Längen	Cadre Largeurs Longueurs	Frame Widths Lengths	140, 160, 180, 200 190, 200, 210, 220
Road used	Füße fixiert Rollen nur optisch Höhe	Pieds fixes Roulettes uniquement décoration Hauteur	Feet fixed Castors only visual Height	20
Naturo M	Kopfteil	Tête de lit	Headboard	140, 160, 180, 200

Alle Holzteile in Wildeiche natur, gebürstet, geölt | Toutes les parties en bois en chêne nouveau, brossé, huilé | All wooden parts in wildoak natural, brushed, oiled
Atrine, Twia: Korpus Anthracit | Caisson anthracite | Body anthracite
Weitere Beimöbel siehe Gesamtkatalog Register 2 | Autres accessoires voir catalogue général registre 2 | Further accessories see general catalogue index 2

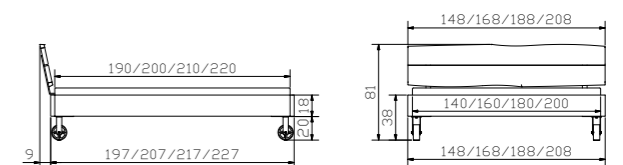



				Dimension cm
Topa	Bank inkl. Kissen Boston tizo 654	Banquette, coussin incl. Boston tizo 654	bench, cushion incl. Boston tizo 654	144/44/38
Caja	Nachttisch	Table de nuit	bedside table	48/41/16

				Dimension cm
Cadro 18	Rahmen Breiten Längen	Cadre Largeurs Longueurs	Frame Widths Lengths	140, 160, 180, 200 190 (210), 200 (220)
Slid anthracit	Kufen Breiten Höhen	Patins Largeurs Hauteurs	Vats Widths Heights	140, 160, 180, 200 20, 25
Ceneri	Kopfteil, Boston tizo 654 hat Einfluss auf Bettlänge siehe Gesamtkatalog Register 1 Seite 4	Tête de lit, Boston tizo 654 a un impact sur la longueur du lit voir catalogue général registre 1 page 4	Headboard, Boston tizo 654 affects the length of bed see general catalogue index 1 page 4	140, 160, 180, 200

Alle Holzteile in Wildeiche coffee, gebürstet, geölt | Toutes les parties en bois en chêne coffee, brossé, huilé | All wooden parts in wildoak coffee, brushed, oiled
Weitere Beimöbel siehe Gesamtkatalog Register 2 | Autres accessoires voir catalogue général registre 2 | Further accessories see general catalogue index 2

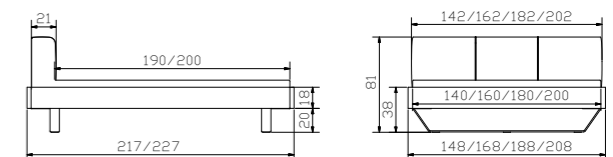



Dimension cm

Caja	Nachttisch	Table de nuit	Bedside table	48/41/166
Claudio alu	Herrendiener	Valet	Dressboy	45/28/107
Calmo	Bank	Banquette	Bench	140/37/38
Vano	Kissen, Cyclo cream 730	Coussin, Cyclo cream 730	Cushion, Cyclo cream 730	136/34/4

Dimension cm

Cadro 23	Rahmen Breiten Längen	Cadre Largeurs Longueurs	Frame Widths Lengths	140, 160, 180, 200 200, 210, 220
Skid	Kufen Breiten Höhe	Patins Largeurs Hauteur	Vats Widths Height	140, 160, 180, 200 25
Naturo L	Kopfteil	Tête de lit	Headboard	140, 160, 180, 200

Alle Holzteile in Wildeiche pure, gebürstet, geölt | Toutes les parties en bois en chêne nouveau pure, brossé, huilé | All wooden parts in wildoak pure, brushed, oiled
 Weitere Beimöbel siehe Gesamtkatalog Register 2 | Autres accessoires voir catalogue général registre 2 | Further accessories see general catalogue index 2

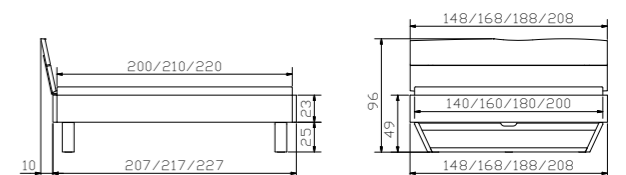



Dimension cm				
Cessina	Kommode	Commode	Chest of drawers	105/46/77
Jone 10 used	Füße	Pieds	Feet	10
Vero	Nachttisch	Table de nuit	Bedside table	50/40/43
Jone 10 used	Füße	Pieds	Feet	10

Dimension cm				
Cadro 23	Rahmen	Cadre	Frame	
	Breiten	Largeurs	Widths	140, 160, 180, 200
	Längen	Longueurs	Lengths	200, 210, 220
Jeno used	Füße	Pieds	Feet	
	Höhen	Hauteurs	Heights	10, 20, 25
Cussina	Kopfteil	Tête de lit	Headboard	140, 160, 180, 200
	Buffalo grey 721	Buffalo grey 721	Buffalo grey 721	140, 160, 180, 200

Alle Holzteile in Wildeiche natur, gebürstet, geölt | Toutes les parties en bois en chêne naturel, brossé, huilé | All wooden parts in wildoak natural, brushed, oiled
 Weitere Beimöbel siehe Gesamtkatalog Register 2 | Autres accessoires voir catalogue général registre 2 | Further accessories see general catalogue index 2

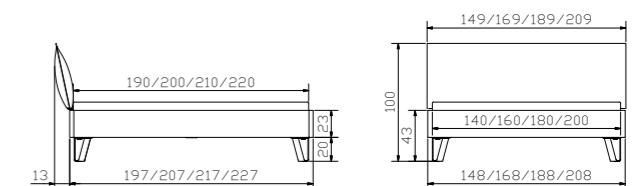



				Dimension cm
Coset	Sekretär	Secrétaire	Bureau	120/60/86
Vecio	Bank/Hocker	Banquette/tabouret	Bench/stool	110/27/45
Onia	Nachttisch	Table de nuit	Bedside table	45/50/41
Curty	Baldachin-Vorhang (3er Set), Baumwolle weiss	Rideau de baldaquin (set de 3), Coton blanc	Curtain of canopy (set of 3), Cotton white	272/185 (3x)

				Dimension cm
Cadro 23	Rahmen Breiten Längen	Cadre Largeurs Longueurs	Frame Widths Lengths	140, 160, 180, 200 200, 210, 220
Cielo anthracit	Baldachin Breiten Höhe	Baldaquin Largeurs Hauteur	Canopy Widths Height	140, 160, 180, 200 20
Naturo L Arona	Kopfteil Kissen, Casual carbon 334	Tête de lit Coussin, Casual carbon 334	Headboard Cushion, Casual carbon 334	140, 160, 180, 200 140, 160, 180/200



Naturo L / Arona

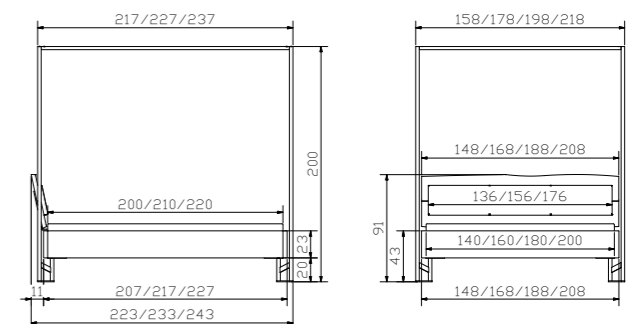

Alle Holzteile in Wildeiche natur, gebürstet, geölt
 Toutes les parties en bois en chêne naturel, brossé, huilé
 All wooden parts in wildoak natural, brushed, oiled

Onia: Korpus anthracit | Caisson anthracite | Body anthracite

Weitere Beimöbel siehe Gesamtkatalog Register 2
 Autres accessoires voir catalogue général registre 2
 Further accessories see general catalogue index 2



				Dimension cm
Coset	Sekretär	Secrétaire	Bureau	120/60/86
Vecio	Bank	Banquette	Bench	110/27/45
Cessina	Kommode	Commode	Chest of drawers	105/46/77
Seca iron	Griffe (3er Set)	Poignées (set de 3)	Handles (set of 3)	
Carpi	Nachttisch höhenverstellbar	Table de nuit réglable en hauteur	Bedside table adjustable in height	52/42/34–53

				Dimension cm
Cadro 23	Rahmen Breiten Längen	Cadre Largeurs Longueurs	Frame Widths Lengths	140, 160, 180, 200 200, 210, 220
Indus iron	Kufen Breiten Höhen	Patins Largeurs Hauteurs	Vats Widths Heights	140, 160, 180, 200 20, 25
Sion	Kopfteil	Tête de lit	Headboard	140, 160, 180, 200
Ravo	Kissen, Alpina anthrazit 391	Coussin, Alpina anthrazit 391	Cushion, Alpina anthrazit 391	140, 160, 180, 200

Alle Holzteile in Wildeiche natur, gebürstet, geölt | Toutes les parties en bois en chêne nouveau, brossé, huilé | All wooden parts in wildoak natural, brushed, oiled
 Weitere Beimöbel siehe Gesamtkatalog Register 2 | Autres accessoires voir catalogue général registre 2 | Further accessories see general catalogue index 2

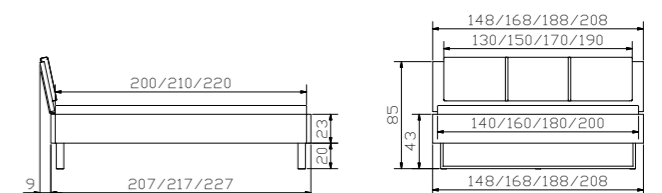



				Dimension cm
Coset	Sekretär	Secrétaire	Bureau	120/60/86
Vero	Nachttisch	Table de nuit	Bedside table	50/40/43
Slid anthracit	Kufen Breiten Höhen	Patins Largeurs Hauteurs	Vats Widths Heights	140, 160, 180, 200 20, 25
Carpi	Nachttisch höhenverstellbar	Table de nuit réglable en hauteur	Bedside table adjustable in height	52/42/34-53

				Dimension cm
Aosta 16	Rahmen Breiten Längen	Cadre Largeurs Longueurs	Frame Widths Lengths	140, 160, 180, 200 200, 210, 220
Ivio	Füße Höhen	Pieds Hauteurs	Feet Heights	10, 20, 25, 30
Naturo M	Kopfteil	Tête de lit	Headboard	140, 160, 180, 200



Alle Holzteile in Wildeiche natur, gebürstet, geölt
 Toutes les parties en bois en chêne naturel, brossé, huilé
 All wooden parts in wildoak natural, brushed, oiled

Weitere Beimöbel siehe Gesamtkatalog Register 2
 Autres accessoires voir catalogue général registre 2
 Further accessories see general catalogue index 2

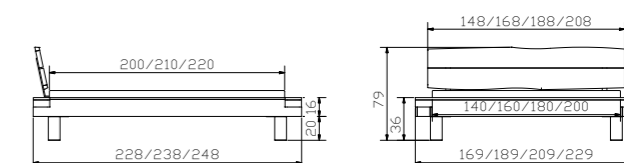



Pilatus 23

				Dimension cm
Alpa	Kopfteil	Tête de lit	Headboard	140, 160, 180, 200

				Dimension cm
Pilatus 23	Rahmen Breiten Längen	Cadre Largeurs Longueurs	Frame Widths Lengths	140, 160, 180, 200 200, 210, 220
Ivio	Füsse Höhen	Pieds Hauteurs	Feet Heights	10, 20, 25, 30
Sion	Kopfteil	Tête de lit	Headboard	140, 160, 180, 200
Caja	Nachttisch	Table de nuit	Bedside table	48/41/16

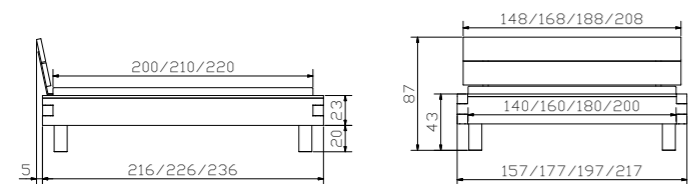

Alle Holzteile in Wildeiche natur, gebürstet, geölt
 Toutes les parties en bois en chêne naturel, brossé, huilé
 All wooden parts in wildoak natural, brushed, oiled
Weitere Beimöbel siehe Gesamtkatalog Register 2
 Autres accessoires voir catalogue général registre 2
 Further accessories see general catalogue index 2

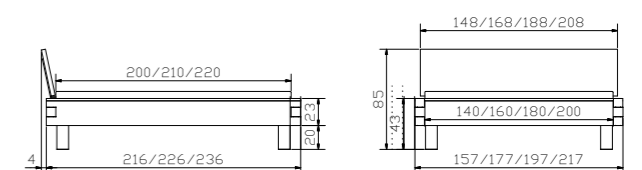

OAK WILD VINTAGE





Dimension cm				
Claudio anthracit	Herrendiener	Valet	Dressboy	45/28/107
Ludo	Nachttisch/Hocker	Table de nuit/Tabouret	Bedside table/stool	40/40/55
Slid anthracit	Kufen Breiten Höhen	Patins Largeurs Hauteurs	Vats Widths Heights	140, 160, 180, 200 20, 25



Dimension cm				
Cadro 23	Rahmen Breiten Längen	Cadre Largeurs Longueurs	Frame Widths Lengths	140, 160, 180, 200 200, 210, 220
Jeno anthracit	Füsse Höhen	Pieds Hauteurs	Feet Heights	10, 20, 25
Obag	Kopfteil Casual carbon 334 siehe Gesamtkatalog Register 1	Tête de lit Casual carbon 334 voir catalogue général registre 1	Headboard Casual carbon 334 see general catalogue index 1	140, 160, 180, 200

Alle Holzteile in Wildeiche Vintage natur, geölt
toutes les parties en bois en chêne nouveau Vintage naturel, huilé
all wooden parts in wildoak Vintage natural, oiled

Weitere Beimöbel siehe Gesamtkatalog Register 2
Autres accessoires voir catalogue général registre 2
Further accessories see general catalogue index 2

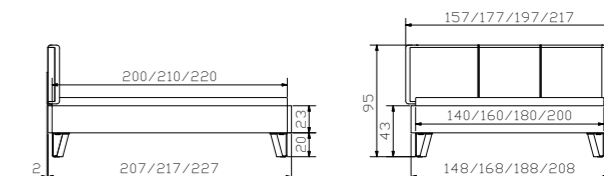



Cadro 18

Dimension cm

Cessina	Kommode	Commode	Chest of drawers	105/46/77
Carpi	Nachttisch höhenverstellbar	Table de nuit réglable en hauteur	Bedside table adjustable in height	52/42/34-53
Snake alu	Leselampe (2er Set) 12V DC, 6 LED 3 Beleuchtungsarten	Lampe de lecture (set de 2) 12V DC, 6 LED 3 différent illuminations	Reading lamp (set of 2) 12V DC, 6 LED 3 different illuminations	

Dimension cm

Cadro 18	Rahmen Breiten Längen	Cadre Largeurs Longueurs	Frame Widths Lengths	140, 160, 180, 200 190, 200, 210, 220
Jeno anthracit	Füße Höhen	Pieds Hauteurs	Feet Heights	10, 20, 25
Naturo L	Kopfteil	Tête de lit	Headboard	140, 160, 180, 200

Alle Holzteile in Wildeiche Vintage natur, geölt | Toutes les parties en bois en chêne nouveau Vintage naturel, huilé | All wooden parts in wildoak Vintage natural, oiled
Leselampen und weitere Beimöbel siehe Gesamtkatalog Register 2 | Lampes de lecture et autres accessoires voir catalogue général registre 2 | Reading lamps and further accessories see general catalogue index 2

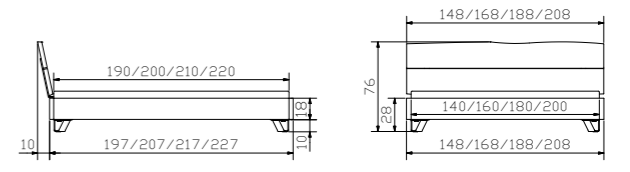

OAK WILD ASPINO BORMIO CORTINA



Betten | Lits | Beds

Bormio 18



Breiten | Largeurs | Widths:
140, 160, 180, 200 cm

Längen | Longueurs | Lengths:
200, 210, 220 cm

Fusshöhen | Hauteur des pieds | Foot heights:
10, 20, 25 cm

Einlegetiefe | Hauteur encastrable | Insertion depth:
18 cm

Cortina 18



Breiten | Largeurs | Widths:
140, 160, 180, 200 cm

Längen | Longueurs | Lengths:
200, 210, 220 cm

Fusshöhen | Hauteur des pieds | Foot heights:
10, 20, 25 cm

Einlegetiefe | Hauteur encastrable | Insertion depth:
18 cm

Aspino 18



Breiten | Largeurs | Widths:
140, 160, 180, 200 cm

Längen | Longueurs | Lengths:
200, 210, 220 cm

Fusshöhe | Hauteur des pied | Foot height:
20 cm

Einlegetiefe | Hauteur encastrable | Insertion depth:
18 cm

Ausführungen | Exécutions | Executions

Holz | Bois | Wood



93
Wildeiche natur, gebürstet, geölt
Chêne nouveau naturel, brossé, huilé
Wildoak natural, brushed, oiled

Traversen | Traverses | Bars

Wir empfehlen grundsätzlich den Einsatz von Crosstraver (Quertraverse) oder Midtraver (Längstraverse).
Nous recommandons en général l'utilisation de Crosstraver (traverse transversale) ou Midtraver (traverse centrale).
We recommend basically the insertion of Crosstraver (central cross bar) or Midtraver (central bar).

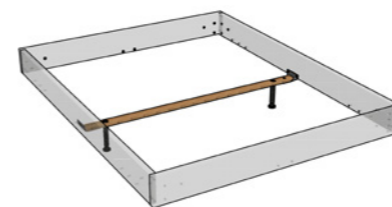

Crosstraver
Quertraverse | Traverse transversale | Central cross bar

Für alle Bettbreiten | Pour toutes les largeurs de lit | For all bed widths

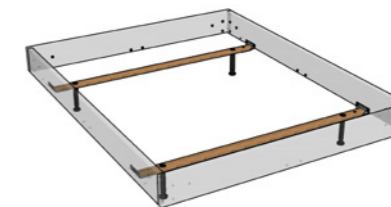

Crosstraver-Twin
Quertraversen | Traverses transversales | Cross bars

Für alle Bettbreiten | Pour toutes les largeurs de lit | For all bed widths

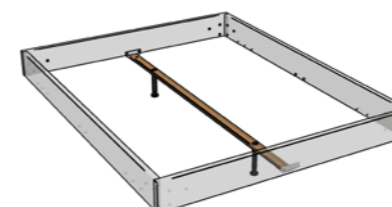

Midtraver
Längstraverse | Traverse centrale | Central bar

Für Betten ab Breite 140 cm mit 2 Lattenrosten oder Motorrahmen-einbau | Pour les lits à partir de 140 cm de largeur avec 2 sommiers ou l'installation d'un cadre motorisé | For beds from 140 cm width with 2 slats or motor frame installation

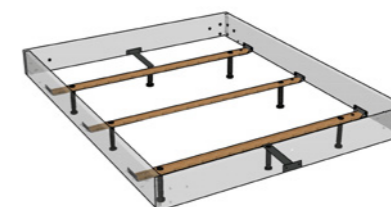

Crosstraver-XXL
Quertraversen | Traverses transversales | Cross bars

Für alle Bettbreiten | Pour toutes les largeurs de lit | For all bed widths

Übersicht Kompatibilität Traversen siehe Gesamtkatalog Seite 2.12 | Aperçu compatibilité traverses voir catalogue général page 2.12 | Overview compatibility bars see general catalogue page 2.12

Bettkasten | Coffres à literie | Bedding boxes

Roll-Box 20/25



Bettkasten in weiss oder anthrazit (Boden weiss)

Voraussetzung
Bettfusshöhe von mindestens 20 cm erforderlich

Optionen
Deckel Covero in weiss, Stoffabdeckung Saceto in Polyester grau.

Roll-Box 20/25 + Covero



Tiroir de lit en blanc ou anthracite (fond blanc)

Condition préalable
Une hauteur de pieds de lit d'au moins 20 cm est nécessaire

Options
Couvercle Covero en blanc, tissu de protection Saceto en polyester gris.

Roll-Box 20/25 + Saceto



Bed drawer in white or anthracite (bottom white)

Condition
Feet of bed need a minimum height of 20 cm

Options
Covero in white, tissue of protection Saceto in polyester grey.



Roll-Box 20

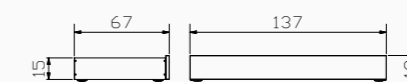

Roll-Box 25

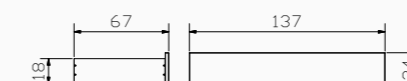

Stauraum | Espace de rangement | Storage space

Roll-Box 20	=	134×61×13 cm
Roll-Box 25	=	134×61×16 cm

Aspino 18



				Dimension cm
Menza	Nachttisch	Table de nuit	Bedside table	48/38/40

				Dimension cm
Aspino 18	Rahmen Breiten Längen Höhe	Cadre Largeurs Longueurs Hauteur	Frame Widths Lengths Height	140, 160, 180, 200 200, 210, 220 20
Alpa + Lumo	Kopfteil Boucle ivory 770	Tête de lit Boucle ivory 770	Headboard Boucle ivory 770	140, 160, 180, 200

Alle Holzteile in Wildeiche natur, gebürstet, geölt | Toutes les parties en bois en chêne nouveau, brossé, huilé | All wooden parts in wildoak natural, brushed, oiled
Weitere Beimöbel siehe Gesamtkatalog Register 2 | Autres accessoires voir catalogue général registre 2 | Further accessories see general catalogue index 2

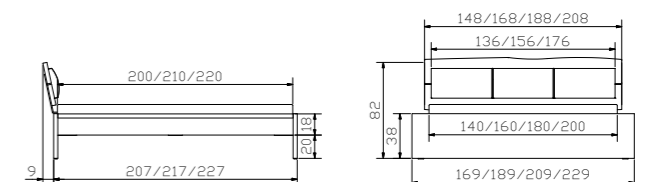



				Dimension cm
Cessina	Kommode	Commode	Chest of drawers	105/48/77
Roll-Box 20	Bettkasten Höhen	Tiroir de lit Hauteurs	Bed drawer Heights	137/67 20, 25
Turina	Nachttisch	Table de nuit	Bedside table	50/42/57

				Dimension cm
Bormio 18	Rahmen Breiten Längen	Cadre Largeurs Longueurs	Frame Widths Lengths	140, 160, 180, 200 200, 210, 220
Sion Sano	Kopfteil Kissen (2er Set) Vintage fango 520	Tête de lit Coussins (Set de 2) Vintage fango 520	Headboard Cushions (Set of 2) Vintage fango 520	140, 160, 180, 200 55/4/35



Alle Holzteile in Wildeiche natur, gebürstet, geölt
 Toutes les parties en bois en chêne naturel, brossé, huilé
 All wooden parts in wildoak natural, brushed, oiled
Weitere Beimöbel siehe Gesamtkatalog Register 2
 Autres accessoires voir catalogue général registre 2
 Further accessories see general catalogue index 2

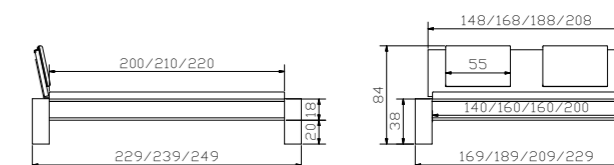

Cortina 18



				Dimension cm
Cuba	Nachttisch	Table de nuit	Bedside table	50/40/43

				Dimension cm
Cortina 18	Rahmen Breiten Längen	Cadre Largeurs Longueurs	Frame Widths Lengths	140, 160, 180, 200 200, 210, 220
Sion	Kopfteil	Tête de lit	Headboard	140, 160, 180, 200

Alle Holzteile in Wildeiche natur, gebürstet, geölt | Toutes les parties en bois en chêne nouveau, brossé, huilé | All wooden parts in wildoak natural, brushed, oiled
Weitere Beimöbel siehe Gesamtkatalog Register 2 | Autres accessoires voir catalogue général registre 2 | Further accessories see general catalogue index 2

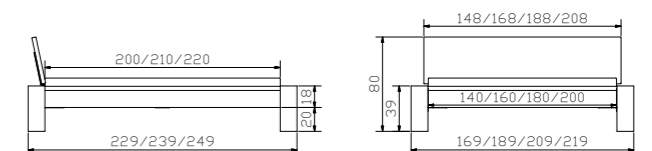



MOVIE-/TOP LINE



FACTORY LINE



WOOD LINE



LOUNGE



FINE LINE



NATURO LINE



OAK LINE



OAK WILD



DREAM LINE



**EDITION
BOXSPRING**



**FUNCTION/COMFORT
KIDS & GUESTS**



**LATTENROSTE &
MATRATZEN**



Gesamtkatalog
Catalogue général
General catalogue