



swiss bed concept



WOOD LINE

MASSIVHOLZ | BOIS MASSIF | SOLID WOOD

Achten Sie auf FSC®-zertifizierte Produkte | Soyez attentifs aux produits certifiés FSC® | Look for FSC®-certified products



Hasena – mein Bett

Hasena – mon lit | Hasena – my bed

Beständige Passion

Une passion constante
Enduring Passion

Mehr als ein Lebenswerk

Als Familienunternehmen gegründet, überzeugen wir seit über 70 Jahren mit hoher Qualität und Vielseitigkeit im Bereich Schlafzimmermöbel.

Plus que l'œuvre d'une vie

Fondée en tant qu'entreprise familiale, nous convainquons depuis plus de 70 ans par notre qualité élevée et notre polyvalence dans le domaine des meubles de chambre à coucher.

More than a life's work

Founded as a family business, we have been impressing with high quality and versatility in the field of bedroom furniture for over 70 years.



swiss bed concept



swiss bed concept

Ein cleveres Baukastensystem

Sie wählen Ihren favorisierten Bettrahmen aus und kombinieren dazu Füße und Kopfteil Ihrer Wahl. Dabei können Sie quer durch die Kollektionen auf unterschiedliche Materialien und Farben zugreifen.

Un système modulaire astucieux

Vous choisissez votre cadre de lit préféré et le combinez avec les pieds et les têtes de lit de votre choix. Vous pouvez choisir parmi une variété de matériaux et de couleurs dans toutes les collections.

A clever modular system

You choose your favourite bed frame and combine it with the feet and headboards of your choice. You can choose from a variety of materials and colours throughout the collections.

5 Jahre Garantie

Service de livraison rapide
5 years warranty



Unser Versprechen

Vom Baum zum Bett – mittels handwerklicher Perfektion und hochwertigen Materialien. Sie erhalten 5 Jahre Garantie auf die Material- und Oberflächenbeschaffenheit, sowie die fachgerechte Verarbeitung aller Modelle ab Kaufdatum. Weitere Informationen finden Sie auf unserer Website.

Notre promesse

De l'arbre au lit – grâce à un artisanat parfait et des matériaux de haute qualité. Vous bénéficiez d'une garantie de 5 ans sur la qualité des matériaux et des surfaces, ainsi que sur la fabrication professionnelle de tous les modèles à compter de la date d'achat. Vous trouverez plus d'informations sur notre site Internet.

Our promise

From tree to bed – by means of perfect craftsmanship and high-quality materials. You receive a 5-year guarantee on the material and surface quality, as well as the professional workmanship of all models from the date of purchase. Further information can be found on our website.

Schnellieferservice

Service de livraison rapide
Quick delivery service



Komfort ohne Wartezeit

Mit unserem Schnellieferservice «PRONTO» können wir eine grosse Auswahl an Betten mit Beimöbeln und alle Modelle aus Edition pronto, Dream pronto und Boxspring pronto ab Lager liefern.

Le confort sans attente

Notre service de livraison rapide « PRONTO » permet de livrer un large choix de lits, de meubles d'appoint et tous les modèles de l'Édition Pronto, Dream pronto et Boxspring Pronto à partir du stock.

Comfort without waiting

With our quick delivery service «PRONTO» we can offer a large selection of beds with ancillary furniture and all models from models from Edition pronto, Dream pronto and Boxspring pronto from stock.



Vielseitig kombinierbar

Unser ausgeklügeltes Baukastensystem «swiss bed concept» bietet eine riesige Auswahl an Füßen, Kopfteilen und Beimöbeln. Darüber hinaus umfasst es verschiedene Stoff-, Kunstleder- und Lederbezüge sowie diverse Holz- und Metallausführungen. Abgestimmte Lattenroste und Matratzen komplettieren unsere Betten zur Wohlfühloase.

Combinable à versatile

Notre système modulaire sophistiqué «swiss bed concept» propose un choix énorme de pieds, têtes de lits et accessoires. Par ailleurs le comporte différents tissus, cuirs synthétiques et véritables, ainsi que diverses variantes de bois et métal. Des sommiers à lattes et des matelas adaptés complètent nos lits pour un espace bien-être.

Versatile combinable

Our ingenious modular system «swiss bed concept» offers a huge selection of feet, headboards and accessories. In addition, it includes different fabrics, synthetic leather and real leather covers and different wood and metal versions. Matching slatted frames and mattresses complete our beds to an oasis of well-being.



Stabil im Aufbau

Unsere Betten überzeugen durch eine hohe Stabilität. Mittels Einsatz verschiedener Traversen ist eine gesamthafte Belastung von 300 bis 450 kg, inklusive Lattenroste und Matratzen, möglich.

Construction robuste

Nos lits sont convaincants par leur grande stabilité. En utilisant différentes fermes, une charge totale de 300 à 450 kg, y compris les sommiers à lattes et les matelas, est possible.

Solid in construction

Our beds convince with their high stability. By using different trusses, a total load of 300 to 450 kg, including slatted frames and mattresses, is possible.



Einfach in der Montage

Unser Betten-System begeistert durch einen einfachen Aufbau mit leicht verständlicher Montageanleitung sowie hochwertigen Verbindungselementen, welche einen vielfachen Ab- und Wiederaufbau ermöglichen.

Montage facile

Notre système de lits séduit par une installation facile grâce aux instructions de montage bien compréhensibles ainsi que par les éléments de fixation haut de gamme permettant de monter et démonter les lits à de nombreuses reprises.

Solid in construction

Our beds convince with their high stability. By using different trusses, a total load of 300 to 450 kg, including slatted frames and mattresses, is possible.

Nachhaltigkeit bei Hasena

Unser wichtigster Lieferant, die Natur, ist sensibel und benötigt lange Regenerationszeiten bei Überbeanspruchung. Wir respektieren die von uns genutzten Ökosysteme und stellen unsere Produkte nachhaltig und mit hohem sozialen Engagement her.

Durabilité chez Hasena

Notre fournisseur le plus important, la nature, est sensible et nécessite un long temps de régénération en cas de surutilisation. Nous respectons les écosystèmes que nous utilisons et fabriquons nos produits de manière durable et avec un haut niveau d'engagement social.

Sustainability at Hasena

Our most important supplier, nature, is sensitive and needs long regeneration times in case of overuse. We respect the ecosystems we use and manufacture our products sustainably and with a high level of social commitment.



Soziale Verantwortung

Responsabilité sociale
Social responsibility



Holzbeschaffung

Approvisionnement en bois
Wood procurement



Produktion Massivholz

Production bois massif
Manufacturing solid wood



Holzoberflächen

Surfaces en bois
Wood surfaces



Recycelte Stoffe

Tissus recyclés
Recycled fabrics



Energiegewinnung

Production énergétique
Production of energy



Bettrahmen | Cadre de lit | Bedframe



Classic 16



Der Classic 16 Rahmen ist nicht in Eiche bright und Eiche brandy erhältlich.
Le cadre Classic 16 n'est pas disponible en chêne bright et en chêne brandy.
The Classic 16 frame is not available in oak bright and oak brandy.



Breiten | Largeurs | Widths:
90, 100, 120, 140, 160, 180, 200 cm
Längen | Longueurs | Lengths: 190, 200, 210, 220 cm
Einlegetiefe | Hauteur encastrable | Insertion depth:
16 cm

Premium 18



Breiten | Largeurs | Widths:
90, 100, 120, 140, 160, 180, 200 cm
Längen | Longueurs | Lengths:
200, 210, 220 cm
Einlegetiefe | Hauteur encastrable | Insertion depth:
18 cm

Premium 23



Breiten | Largeurs | Widths:
140, 160, 180, 200 cm
Längen | Longueurs | Lengths:
200, 210, 220 cm
Einlegetiefe | Hauteur encastrable | Insertion depth:
18*, 23 cm

Ausführungen | Exécutions | Executions

Holz | Bois | Wood



- | | | | | | |
|---|---|---|---|---|---|
| <p>06
Buche natur, lackiert
Hêtre naturel, laqué
Natural beech, lacquered</p> | <p>07
Buche schoko, lackiert
Hêtre teinté chocolat, laqué
Beech chocolate coloured, lacquered</p> | <p>09
Buche weiss lasiert, lackiert
Hêtre teinté blanc lasuré, laqué
Beech white stained, lacquered</p> | <p>74
Eiche bright, geölt
Chêne bright, huilé
Oak bright, oiled</p> | <p>76
Eiche brandy, geölt
Chêne brandy, huilé
Oak brandy, oiled</p> | <p>80
Kernbuche natur, geölt
Hêtre cœur rouge naturel, huilé
Heart beech natural, oiled</p> |
|---|---|---|---|---|---|

Traversen | Traverses | Bars

Wir empfehlen grundsätzlich den Einsatz von Crosstraver (Quertraverse) oder Midtraver (Längstraverse).
Nous recommandons en général l'utilisation de Crosstraver (traverse transversale) ou Midtraver (traverse centrale).
We recommend basically the insertion of Crosstraver (central cross bar) or Midtraver (central bar).

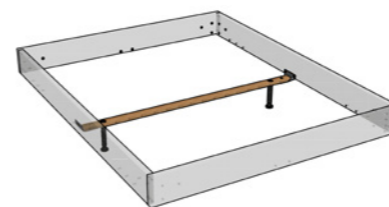

Crosstraver
Quertraverse | Traverse transversale | Central cross bar

Für alle Bettbreiten | Pour toutes les largeurs de lit | For all bed widths

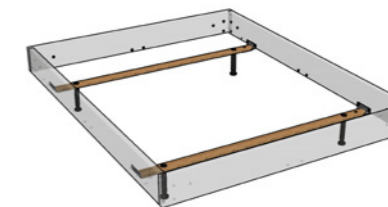

Crosstraver-Twin
Quertraversen | Traverses transversales | Cross bars

Für alle Bettbreiten | Pour toutes les largeurs de lit | For all bed widths

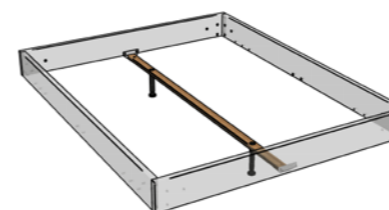

Midtraver
Längstraverse | Traverse centrale | Central bar

Für Betten ab Breite 140 cm mit 2 Lattenrosten oder Motorrahmen-einbau | Pour les lits à partir de 140 cm de largeur avec 2 sommiers ou l'installation d'un cadre motorisé | For beds from 140 cm width with 2 slats or motor frame installation

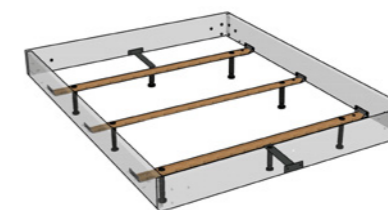

Crosstraver-XXL
Quertraversen | Traverses transversales | Cross bars

Für alle Bettbreiten | Pour toutes les largeurs de lit | For all bed widths

Übersicht Kompatibilität Traversen siehe Gesamtkatalog Seite 2.12 | Aperçu compatibilité traverses voir catalogue général page 2.12 | Overview compatibility bars see general catalogue page 2.12

* Premium 23

Bei der Einlegetiefe 18 cm sind die Füße/Socket um 5 cm versenkt und um diese Höhe weniger sichtbar.

Avec les équerres en position haute (18 cm) les pieds/socle sont encastrés de 5 cm sous le cadre et donc moins visibles.
With the insertion depth 18 cm the feet/socket are sunken in by 5 cm and this height less visible.

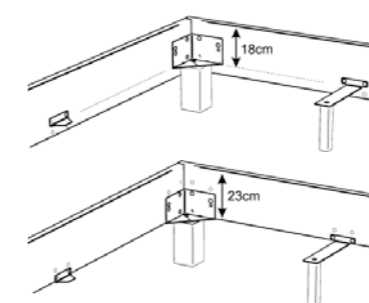

Option Midtraver-move

Achtung: nicht bei Füßen in der Höhe 30 cm, Lovie-Box und Practico-Box einsetzbar

Attention : ne s'applique pas aux pieds à une hauteur de 30 cm, Lovie-Box et Practico-Box
Attention: not applicable for feet at a height of 30 cm, Lovie-Box and Practico-Box

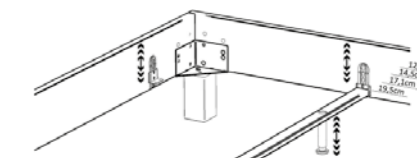

Modern, einzigartig, wertbeständig

Unsere Wood-Line ist ebenso langlebig wie das Holz, aus dem es gemacht ist und bietet Schlafkomfort auf hohem Niveau: modern, zeitlos und wertbeständig. Natürlich gewachsene Unregelmäßigkeiten in Farbe, Maserung und Oberfläche schenken dem massiven Holz und den Möbeln dieser Linie einen sehr natürlichen und einzigartigen Charakter.

Moderne, unique, de valeur stable

Le concept Wood-Line est aussi durable que le bois dont il est fait et offre un grand confort de sommeil : moderne, intemporel et durable. Les irrégularités naturelles de couleur, de grain et de surface donnent au bois massif et aux meubles de cette ligne un caractère très naturel et unique.

Modern, unique, stable in value

The Wood-Line concept is just as durable as the wood it is made of and offers a high level of sleeping comfort: modern, timeless and of lasting value. Naturally grown irregularities in colour, grain and surface give the solid wood and furniture of this line a very natural and unique character.

Füsse | Pieds | Feet

Holz | Bois | Wood

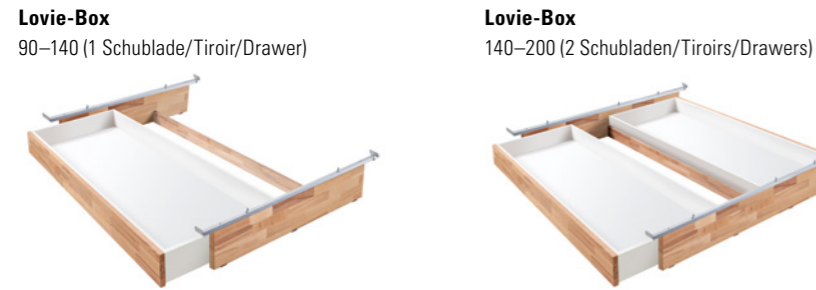

Standard: gedämpfter Selbsteinzug Blumotion von BLUM
Option: Tip-On-Öffnung mit Vollauszug von BLUM
Standard: système d'amortissement Blumotion de BLUM
Option: ouverture Tip-On avec sortie totale de BLUM
Standard: soft closing runner Blumotion of BLUM
Option: opening Tip-On with full extension of BLUM

Holz Bois Wood	Masse cm Dim. cm	Breiten cm Largeurs cm Widths cm	Höhen cm Hauteurs cm Heights cm				Holzfarben Couleurs bois Colours wood												
			10	20	25	30	06	07	09	10	16	74	76	80					
Amigo*	10x10		14 cm																
Lana																			
Cantu	8x8																		
Evio		90-200																	
Ivio	10x10																		
Juve	8x8																		
Masi	6x5,5																		
Lovie-Box** (1 Schublade/Tiroir/Drawer)		90-140																	
Lovie-Box** (2 Schubladen/Tiroirs/Drawers)		140-200																	
Massa**	16x16																		
Practico-Box (inkl. Boden fond inclus bottom included)		90-200																	
Vilo		90-200																	

Practico-Box aus MDF ummantelt. Holzfüsse sind aus Massivholz | Practico-Box en mdf laminé. Pieds en bois massif | Practico-Box in mdf coated. Wooden feet are of solid wood.
 *nur mit Classic 16 Rahmen möglich | uniquement possible avec cadre Classic 16 | only possible with frame Classic 16
 **bei Premium 23 nur Einlegetiefe 23 cm möglich | pour Premium 23 uniquement possible avec hauteur encastrable de 23 cm | for Premium 23 possible with insertion depth of 23 cm

06 Buche natur, lackiert Hêtre naturel, laqué Natural beech, lacquered	07 Buche schoko, lackiert Hêtre teinté chocolat, laqué Beech chocolate coloured, lacquered	09 Buche weiss lasiert, lackiert Hêtre teinté blanc lasuré, laqué Beech white stained, lacquered	10 Buche weiss deckend, lackiert Hêtre blanc couvrant, laqué Beech white covered, lacquered	16 Buche anthracit deckend, lackiert Hêtre anthracite couvrant, laqué Beech anthracite covered, lacquered
74 Eiche bright, geölt Chêne bright, huilé Oak bright, oiled	76 Eiche brandy, geölt Chêne brandy, huilé Oak brandy, oiled	80 Kernbuche natur, geölt Hêtre coeur rouge naturel, huilé Heart beech natural, oiled		

Füsse | Pieds | Feet

Metall | Métal | Metal

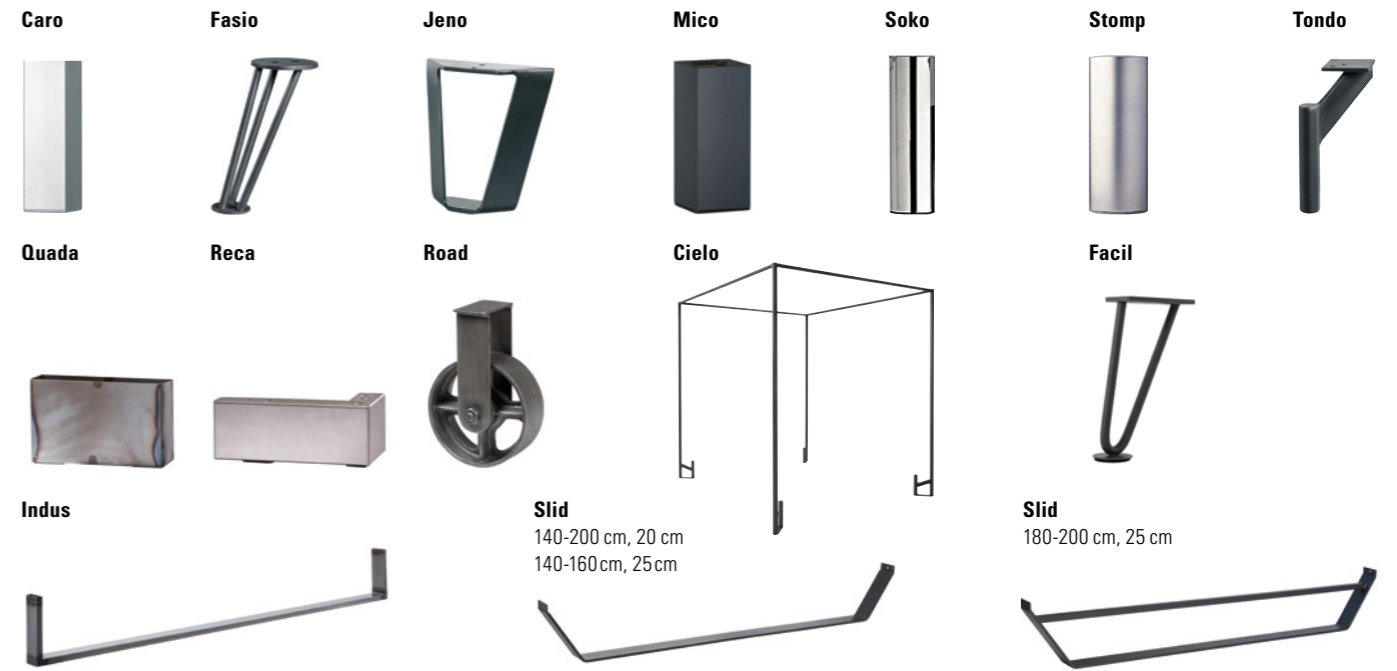

Metall Métal Metal	Masse cm Dim. cm	Breiten cm Largeurs cm Widths cm	Höhen cm Hauteurs cm Heights cm				Metallfarben Couleurs métal Colours metal													
			10	20	25	30	00	04	10	16	40	41	42	43	45					
Caro	6x6																			
Cielo [▲]		120-200																		
Facil																				
Fasio	Ø 5/9																			
Indus	6x2	140-200																		
Jeno	12x5																			
Mico	8x8																			
Quada	20x6,5																			
Reca	24x12																			
Road*	Ø 13																			
Slid	8/1	140-200																		
Soko	Ø 6																			
Stomp	Ø 8																			
Tondo	Ø 3,5																			

* Füsse fixiert, Rollen nur optisch | Pieds fixes, roulettes uniquement décoratives | Feet fixed, castors only visual
[▲] Curty Vorhang und Vela Baldachin-Tuch siehe Gesamtkatalog Register 2, Seite 12 | Curty rideau et Vela tissu de baldaquin voir catalogue général registre 2, page 12 | Curty curtain and Vela canopy cloth see general catalogue index 2, page 12

00 Chrom	04 Used	10 White	16 Anthracit	40 Bronze	41 Copper	42 Alu	43 Inox	45 Iron
00 Chrom = Edelstahl poliert Acier poli Stainless steel polished	04 Used = Stahl galvanisiert Acier galvanisé Steel galvanised	10 White = Stahl pulverbeschichtet Acier thermolaqué Steel powder-coated	16 Anthracit = Stahl pulverbeschichtet Acier thermolaqué Steel powder-coated	40 Bronze = Stahl lackiert Acier laqué Steel lacquered	41 Copper = Stahl lackiert Acier laqué Steel lacquered	42 Alu = Stahl pulverbeschichtet Acier thermolaqué Steel powder-coated	43 Inox = Edelstahl geschliffen Acier poncé Stainless steel ground	45 Iron = Stahl geflammt, pulverbeschichtet Acier flammé, thermolaqué Steel mottled, powder-coated

Kopfteile | Têtes de lit | Headboards

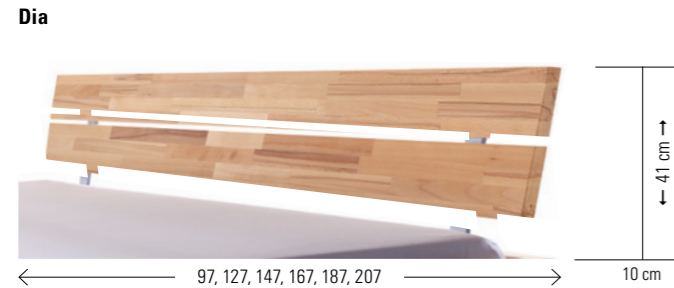

Dimension: 90/100, 120, 140, 160, 180/200

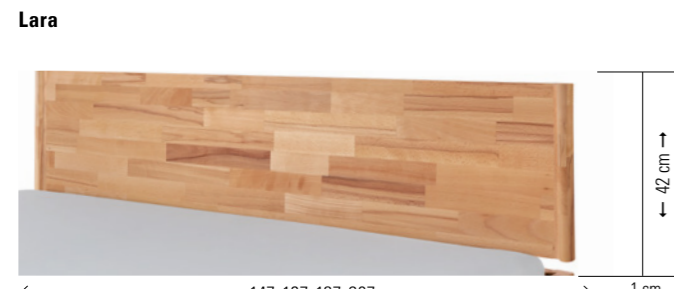

Dimension: 140, 160, 180, 200



Dimension: 90/100, 120, 140, 160, 180, 200



Dimension: 90/100, 120, 140, 160, 180, 200



Dimension: 90/100, 120, 140, 160, 180, 200



Dimension: 140, 160, 180/200



Dimension: 140, 160, 180, 200

Kopfteil | Têtes de lit | Headboard

Holzfarben

Couleurs bois
Colours wood

	06	07	09	74	76	80
Dia	●	●	●	●	●	●
Duetto	●	●	●	●	●	●
Litto	●	●	●	●	●	●
Lara	●	●	●	●	●	●
Sandro	●	●	●	●	●	●
Varus	●	●	●	●	●	●
Vola	●	●	●	●	●	●

Holz | Bois | Wood

 06 Buche natur, lackiert Hêtre naturel, laqué Natural beech, lacquered	 07 Buche schoko, lackiert Hêtre teinté chocolat, laqué Beech chocolate coloured, lacquered	 09 Buche weiss lasiert, lackiert Hêtre teinté blanc lasuré, laqué Beech white stained, lacquered	 74 Eiche bright, geölt Chêne bright, huilé Oak bright, oiled	 76 Eiche brandy, geölt Chêne brandy, huilé Oak brandy, oiled	 80 Kernbuche natur, geölt Hêtre cœur rouge naturel, huilé Heart beech natural, oiled
---	---	---	---	---	---

Kissen zu Kopfteilen | Coussins pour têtes de lit | Cushions for headboards

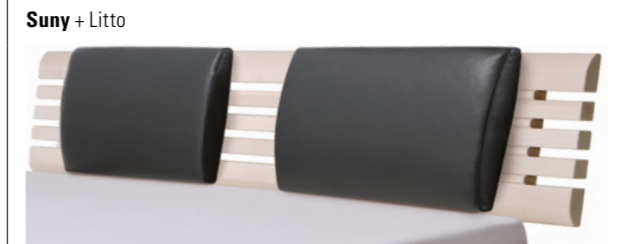

Befestigung mit 2 Bändern (Klettverschluss)
 Fixation avec 2 bandes (Velcro®)
 Fixation with 2 ribbons (Velcro® fastener)

Stoffauswahl/Farben für Kissen siehe Gesamtkatalog Register 1, Seiten 6–7

Choix de tissus/couleurs pour coussins voir catalogue général registre 1, pages 6–7
 Choice of tissues/colours for cushions see general catalogue index 1, pages 6–7

Gepolsterte Kopfteile, Wandpaneele, Stoffauswahl/Farben siehe Gesamtkatalog Register 1, Leselampen siehe Gesamtkatalog Register 2.

Têtes de lits rembourrées, panneaux muraux, choix de tissus/couleurs voir catalogue général registre 1, lampes de lecture voir catalogue général registre 2.
 Upholstered headboards, wallpanels, choice of tissues/colours see general catalogue index 1, reading lamps see general catalogue index 2.

Kissen | Coussins | Cushions

	Effektive Masse cm Dimensions effectives cm Effective dimensions cm
Arona	86, 116, 136, 156, 176×3,5×25
Lumo	86, 116, 136, 156, 176×6×25
Suny (2er Set set de 2 set of 2)	55×6×40
Ravo	80, 110, 130, 150, 170, 190×3,5×35
Varo (2er Set set de 2 set of 2)	55×10×35

zu Kopfteilen

pour têtes de lit
for headboards

	Duetto	Dia	Lara	Litto	Varus
	●	●			
	●	●	●	●	●
	●	●	●	●	●
	●	●		●	●

Breitenmasse cm

Dimensions de largeur cm
widths dimensions cm

90/100, 120, 140, 160, 180/200
90/100, 120, 140, 160, 180/200
90/100, 120, 140, 160, 180, 200

Adapter | Adaptateur | Adapter

Bei hohen Matratzen kann mit dem Verlängerungsadapter das Kopfteil um 9 oder 13 cm erhöht werden.

La tête de lit peut être rehaussée de 9 ou 13 cm avec l'adaptateur quand le matelas est plus épais.

With the extension adapter the headboard can be extended 9 or 13 cm if mattresses are high.

Alu für alle Holzfarben, ausser 74 und 76. Black für Holzfarben 74 und 76.

Alu pour toutes les couleurs de bois, sauf 74 et 76. Black pour les couleurs de bois 74 et 76.

Alu for all wood colours except 74 and 76. Black for wood colours 74 and 76.

Head-Plus

Métal | Metal

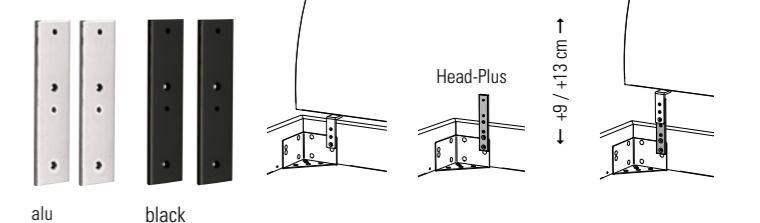

alu

black

selezione

01

MODELLAUSWAHL

Sélection du modèle | Model selection

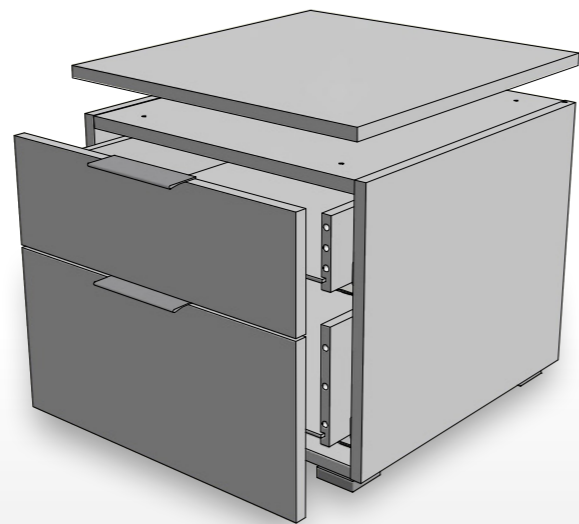

02

KORPUS

Caisson | Body



03

TOP/FRONT

Farben | Couleurs | Colours



04

GRIFFE

Poignées | Handles



Stellen Sie sich Ihr Wunsch-Beimöbel nach Ihrem Geschmack zusammen: Der Korpus (Abb. 02), in zwei verschiedenen Farbvarianten, lässt sich zu den Front- und Top-Covern (Abb. 03) in acht Holz- und Farbausführungen kombinieren. Die Beimöbel können zerlegt oder teilmontiert bestellt werden. Bei zusammengesetzten Möbeln (z. B. Qunito, Incentro, ...) muss der Deckel noch montiert werden. Bei Kommoden mit Türen ist jeweils ein Einlegeboden vorhanden, Türöffnung nach links oder rechts möglich. Zusätzliche Böden sind erhältlich.

Composez le meuble d'appoint de vos rêves selon vos goûts : Le caisson (ill. 02), disponible en 2 variantes de couleurs, peut être combiné avec les façades et couvercles supérieurs (ill. 03) en 8 finitions de bois et de coloris. Les meubles d'appoint peuvent être commandés en kits ou assemblés. Pour les meubles assemblés (p. ex. Qunito, Incentro, ...) le couvercle doit encore être fixé. Les commodes avec portes sont équipées d'une étagère, ouverture de la porte possible à gauche ou à droite. Si besoin, des étagères supplémentaires sont disponibles.

Put together the side furniture you want according to your own taste: The body (fig. 02), in two different colour versions, can be combined with the front and top covers (fig. 03) in eight wood and colour versions. The furniture can be ordered disassembled or assembled. For assembled furniture (e.g. Qunito, Incentro, ...) the top cover must still be fitted. Chests of drawers with doors have one shelf, door opening possible to the left or right. Additional shelves are available.



Kombinationsbeispiele und techn. Informationen
Exemples et informations
Examples and informations

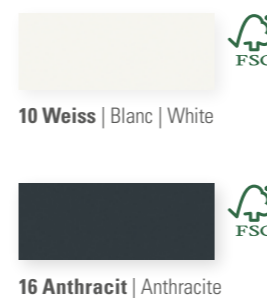

STANDARD



OPTION

Leg 8 cm Jone 10 cm Cila 10 cm

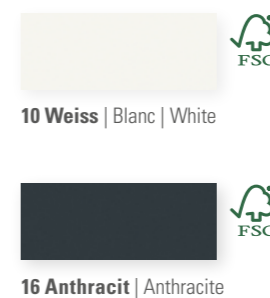

STANDARD

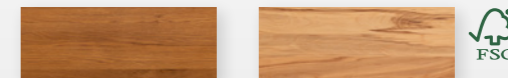
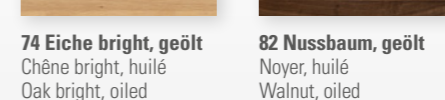

STANDARD



Alu
Griff zu Folienfronten
Poignée pour façades en mélaminé
Handle for foil fronts

STANDARD



Holzgriff zu Holzfronten
Poignée en bois pour façades en bois
Wooden handle for wooden fronts

OPTION

Rivo

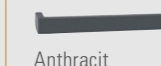
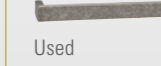

OPTION

Metallgriff zu Holzfronten
Poignée en métal pour façades en bois
Metal handle for wooden fronts



				Dimension cm
Lovara	Kommode	Commode	Chest of drawers	90/40/75
Dupla	Nachttisch	Table de nuit	Bedside table	48/40/35

				Dimension cm
Classic 16	Rahmen Breiten Längen	Cadre Largeurs Longueurs	Frame Widths Lengths	90, 100, 120, 140, 160, 180, 200 190, 200, 210, 220
Masi	Füße Höhen	Pieds Hauteurs	Feet Heights	20, 25
Boga	Kopfteil, Campos blanc 372 siehe Gesamtkatalog Register 1	Tête de lit, Campos blanc 372 voir catalogue général registre 1	Headboard, Campos blanc 372 see general catalogue index 1	90, 100, 120, 140, 160, 180, 200

Alle Holzteile in Kernbuche natur, geölt | Toutes les parties en bois en hêtre cœur rouge naturel, huilé | All wooden parts in heart beech natural, oiled
 Weitere Beimöbel siehe Gesamtkatalog Register 2 | Autres accessoires voir catalogue général registre 2 | Further accessories see general catalogue index 2

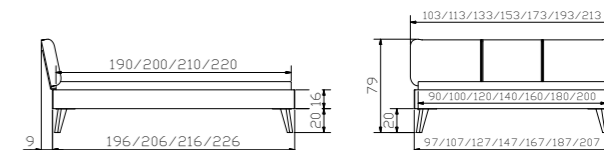



				Dimension cm
Varus	Kopfteil	Tête de lit	Headboard	140, 160, 180, 200
Duetto	Kopfteil	Tête de lit	Headboard	90/100, 120, 140, 160, 180, 200
Arona	Kissen, Kitana grigio 602	Coussin, Kitana grigio 602	Cushion, Kitana grigio 602	90/100, 120, 140, 160, 180/200

				Dimension cm
Classic 16	Rahmen Breiten Längen	Cadre Largeurs Longueurs	Frame Widths Lengths	90, 100, 120, 140, 160, 180, 200 190, 200, 210, 220
Juve	Füße Höhen	Pieds Hauteurs	Feet Heights	20, 25
Dia	Kopfteil	Tête de lit	Headboard	90/100, 120, 140, 160, 180/200
Mido	Nachttisch	Table de nuit	Bedside table	40/35/10

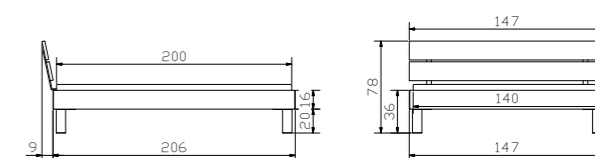
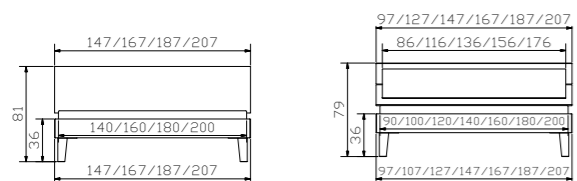

Alle Holzteile in Kernbuche natur, geölt | Toutes les parties en bois en hêtre cœur rouge naturel, huilé | All wooden parts in heart beech natural, oiled

Weitere Beimöbel siehe Gesamtkatalog Register 2 | Autres accessoires voir catalogue général registre 2 | Further accessories see general catalogue index 2



	Dimension cm			
Lovie-Box	1 Bettkasten Breiten	1 Tiroir de lit Largeurs	1 Bed drawer Widths	90, 100, 120, 140
	2 Bettkästen Breiten	2 Tiroirs de lit Largeurs	2 Bed drawers Widths	140, 160, 180, 200
	Höhe	Hauteur	Height	25

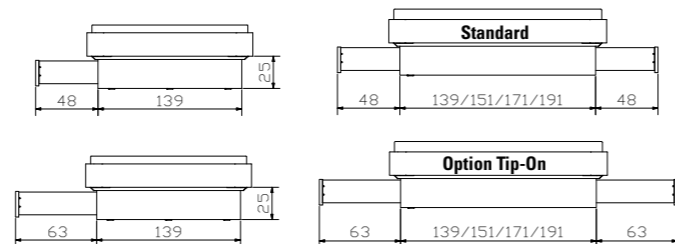

	Dimension cm			
Classic 16	Rahmen Breiten Längen	Cadre Largeurs Longueurs	Frame Widths Lengths	140, 160, 180, 200 190, 200, 210, 220
Indus iron	Kufen Breiten Höhen	Patins Largeurs Hauteurs	Vats Widths Heights	140, 160, 180, 200 20, 25
Elipsa	Kopfteil, Casual cannelle 331 siehe Gesamtkatalog Register 1	Tête de lit, Casual cannelle 331 voir catalogue général registre 1	Headboard, Casual cannelle 331 see general catalogue index 1	140, 160, 180, 200
Caja	Nachttisch	Table de nuit	Bedside table	48/41/16
Aska	Sekretär	Secrétaire	Bureau	120/60/85

Alle Holzteile in Kernbuche natur, geölt | Toutes les parties en bois en hêtre cœur rouge naturel, huilé | All wooden parts in heart beech natural, oiled
Weitere Beimöbel siehe Gesamtkatalog Register 2 | Autres accessoires voir catalogue général registre 2 | Further accessories see general catalogue index 2

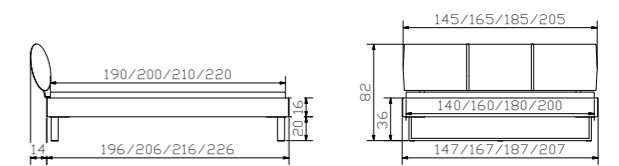



				Dimension cm
Ronna	Kopfteil, Capo rose 762	Tête de lit, Capo rose 762	Headboard, Capo rose 762	90/100, 120, 140, 160, 180, 200
Duetto	Kopfteil	Tête de lit	Headboard	90/100, 120, 140, 160, 180, 200
Arona	Kissen, Capo rose 762	Coussin, Capo rose 762	Cushion, Caop rose 762	90/100, 120, 140, 160, 180/200
Caja	Nachttisch	Table de nuit	Bedside table	48/41/16

				Dimension cm
Classic 16	Rahmen Breiten Längen	Cadre Largeurs Longueurs	Frame Widths Lengths	90, 100, 120, 140, 160, 180, 200 190, 200, 210, 220
Cantu	Füsse Höhen	Pieds Hauteurs	Feet Heights	20, 25, 30
Duetto	Kopfteil	Tête de lit	Headboard	90/100, 120, 140, 160, 180, 200
Lumo	Kissen, Capo rose 762	Coussin, Capo rose 762	Cushion, Capo rose 762	90/100, 120, 140, 160, 180/200
Onia	Nachttisch	Table de nuit	Bedside table	45/49/40
Dowio	Kommode	Commode	Chest of drawers	90/49/55
Roll-Box 20 + Covero	Bettkasten Deckel Covero in weiss	Tiroir de lit Couvercle Covero en blanc	Bed drawer Covero in white	137/67/19

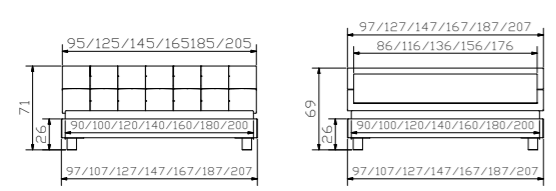

Alle Holzteile in Buche weiss lasiert, lackiert oder weiss | Toutes les parties en bois en hêtre teinté blanc lasuré, laqué ou blanc | All wooden parts in beech white stained, lacquered or white
Weitere Beimöbel siehe Gesamtkatalog Register 2 | Autres accessoires voir catalogue général registre 2 | Further accessories see general catalogue index 2

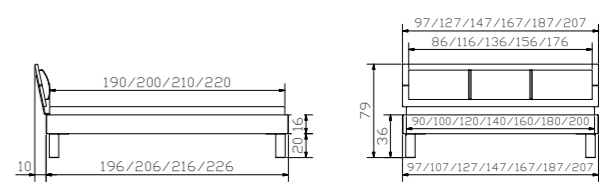



				Dimension cm
Dupla	Nachttisch	Table de nuit	Bedside table	48/40/35
Sola	Bank	Banquette	Bench	144/44/38
Claudio anthracit	Herrendiener	Valet	Dressboy	45/28/107

				Dimension cm
Premium 18	Rahmen Breiten Längen	Cadre Largeurs Longueurs	Frame Widths Lengths	90, 100, 120, 140, 160, 180, 200 200, 210, 220
Slid anthracit	Füße Höhen	Pieds Hauteurs	Feet Heights	20, 25
Sandro	Kopfteil	Tête de lit	Headboard	90/100, 120, 140, 160, 180, 200

Alle Holzteile in Eiche brandy, geölt | Toutes les parties en bois en chêne brandy, huilé | All wooden parts in oak brandy, oiled
Weitere Beimöbel siehe Gesamtkatalog Register 2 | Autres accessoires voir catalogue général registre 2 | Further accessories see general catalogue index 2

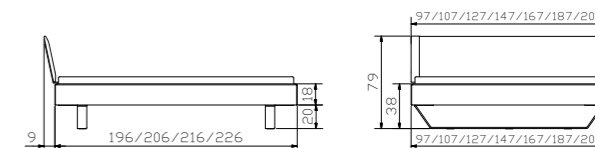



				Dimension cm
Dupla	Nachttisch	Table de nuit	Bedside table	48/40/35

				Dimension cm
Premium 18	Rahmen Breiten Längen	Cadre Largeurs Longueurs	Frame Widths Lengths	90, 100, 120, 140, 160, 180, 200 200, 210, 220
Cielo white	Baldachin Breiten Längen Höhe	Baldaqin Largeurs Longueurs Hauteur	Canopy Widths Lengths Height	120, 140, 160, 180, 200 200/210/220 20
Duetto	Kopfteil	Tête de lit	Headboard	90/100, 120, 140, 160, 180, 200



Curty

Alle Holzteile in Buche weiss lasiert, lackiert
 Toutes les parties en bois en hêtre teinté blanc lasuré, laqué
 All wooden parts in beech white stained, lacquered

Weitere Beimöbel siehe Gesamtkatalog Register 2
 Autres accessoires voir catalogue général registre 2
 Further accessories see general catalogue index 2

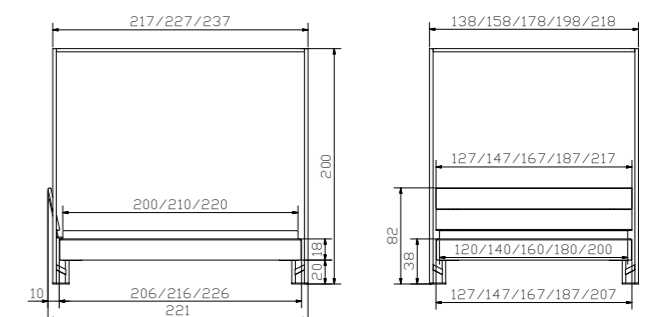



				Dimension cm
Twia	Nachttisch	Table de nuit	Bedside table	45/49/40

				Dimension cm
Premium 18	Rahmen Breiten Längen	Cadre Largeurs Longueurs	Frame Widths Lengths	90, 100, 12140, 160, 180, 200 200, (220)
Tondo anthracit	Füße Höhe	Pieds Hauteur	Feet Height	20
Ceneri	Kopfteil, Casual carbon 334 hat Einfluss auf Bettlänge siehe Gesamtkatalog Register 1 Seite 4	Tête de lit, Casual carbon 334 a un impact sur la longueur du lit voir catalogue général registre 1 page 4	Headboard, Casual carbon 334 affects the length of bed see general catalogue index 1 page 4	140, 160, 180, 200

Alle Holzteile in Kernbuche natur, geölt oder anthracit | Toutes les parties en bois en hêtre coeur rouge naturel, huilé ou anthracite | All wooden parts in heart beech natural, oiled or anthracite

Weitere Beimöbel siehe Gesamtkatalog Register 2 | Autres accessoires voir catalogue général registre 2 | Further accessories see general catalogue index 2

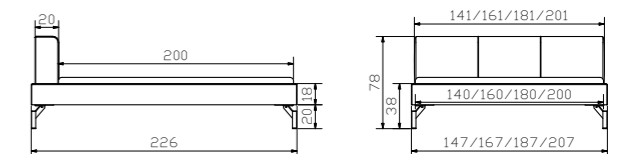



				Dimension cm
Styly	Nachttisch	Table de nuit	Bedside table	43/43/48
Sola	Bank	Secrétaire	Bureau	140/37/38

				Dimension cm
Premium 23	Rahmen Breiten Längen	Cadre Largeurs Longueurs	Frame Widths Lengths	140, 160, 180, 200 200, 210, 220
Lana	Füße Höhen	Pieds Hauteurs	Feet Heights	20, 25
Lara	Kopfteil	Tête de lit	Headboard	140, 160, 180, 200

Alle Holzteile in Eiche bright, geölt | Toutes les parties en bois en chêne bright, huilé | All wooden parts in oak bright, oiled

Lampen und weitere Beimöbel siehe Geamtkatalog Register 2 | Lampes et autres accessoires voir catalogue général registre 2 | Lamps and further accessories see general catalogue index 2

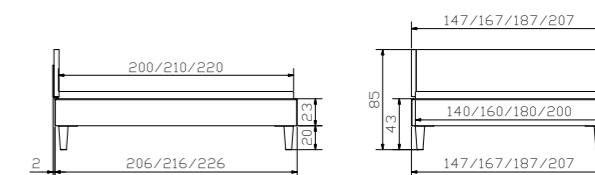





				Dimension cm
Aska	Sekretär	Secrétaire	Bureau	120/60/85
Claudio alu	Herrendiener	Valet	Dressboy	45/28/107
Treva	Nachttisch	Table de nuit	Bedside table	48/40/51

				Dimension cm
Premium 23	Rahmen Breiten Längen	Cadre Largeurs Longueurs	Frame Widths Lengths	120, 140, 160, 180, 200 200, 210, 220
Masi	Füße Höhen	Pieds Hauteurs	Feet Heights	20, 25
Cussina	Kopfteil, Ranch stone 660 siehe Gesamtkatalog Register 1	Tête de lit, Ranch stone 660 voir catalogue général registre 1	Headboard, Ranch stone 660 see general catalogue index 1	140, 160, 180, 200

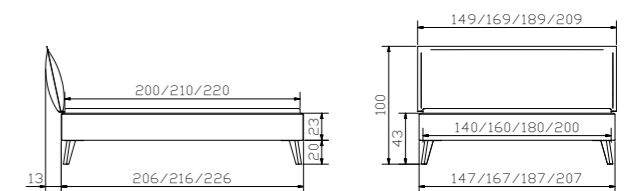
Alle Holzteile in Kernbuche natur, geölt | Toutes les parties en bois en hêtre coeur rouge naturel, huilé | All wooden parts in heart beech natural, oiled
Weitere Beimöbel siehe Gesamtkatalog Register 2 | Autres accessoires voir catalogue général registre 2 | Further accessories see general catalogue index 2





				Dimension cm
Lovara	Kommode	Commode	Chest of drawers	90/40/75
Treva	Nachttisch	Table de nuit	Bedside table	48/40/51
Boa chrom	Leselampe (2er Set) 12V DC, 12 LED warm	Lampe de lecture (set de 2) 12V DC, 12 LED warm	Reading lamp (set of 2) 12V DC, 12 LED warm	

				Dimension cm
Premium 23	Rahmen Breiten Längen	Cadre Largeurs Longueurs	Frame Widths Lengths	140, 160, 180, 200 200, 210, 220
Cantu	Füße Höhen	Pieds Hauteurs	Feet Heights	20, 25, 30
Talma	Kopfteil, Cyclo creme 730 siehe Gesamtkatalog Register 1	Tête de lit, Cyclo creme 730 voir catalogue général registre 1	Headboard, Cyclo creme 730 see general catalogue index 1	140, 160, 180, 200

Alle Holzteile in Eiche bright, geölt | Toutes les parties en bois en chêne bright, huilé | All wooden parts in oak bright, oiled

Leselampen und weitere Beimöbel siehe Gesamtkatalog Register 2 | Lampes de lecture et autres accessoires voir catalogue général registre 2 | Reading lamps and further accessories see general catalogue index 2

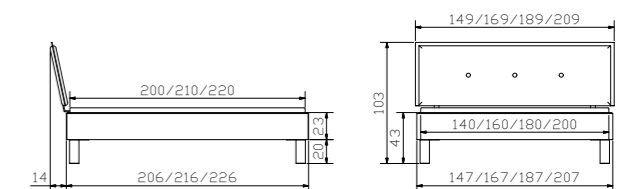



MOVIE-/TOP LINE



FACTORY LINE



WOOD LINE



LOUNGE



FINE LINE



NATURO LINE



OAK LINE



OAK WILD



DREAM LINE



**EDITION
BOXSPRING**



**FUNCTION/COMFORT
KIDS & GUESTS**



**LATTENROSTE &
MATRATZEN**



Gesamtkatalog
Catalogue général
General catalogue