



V-Alpin

Aus Freude am Original

For the satisfaction of being original

Le plaisir du retour aux sources

Wir achten bewusst darauf, die im Holz **charakteristischen Lebenslinien**, aber auch **die Inschrift und Spuren** zu erhalten. Es sind Möbel, die **Individualität und Wärme vermitteln** und zugleich in außergewöhnlicher Weise den Spagat zwischen Tradition und Moderne schaffen.

We make sure that the **wood's characteristic life lines** as well as **inscriptions and marks are retained**. This is furniture that creates a sense of **individuality and warmth** and, at the same time, strikes a stunning balance between tradition and modernity.

Nous nous efforçons de préserver les **lignes de vie caractéristiques** présentes dans le bois mais aussi les traces et inscriptions. Ce sont des meubles qui **transmettent l'individualité et la chaleur** tout en réussissant à concilier d'une manière exceptionnelle la tradition et la modernité.



V-Alpin Video

100% NATUR | nature | nature

100% DESIGN | design | design

100% DURCHDACHT | sophisticated | bien pensé

100% VERANTWORTUNG | responsibility | responsabilité



Design. Natur. Handwerk.

Design – Nature – Craftsmanship

Le design, la nature, l'artisanat



Naturholzmöbel aus nachhaltigem Anbau

Natural wood furniture made from sustainable timber

Meubles en bois naturel issu de plantations durables



Bekanntnis zu Natur und Qualität seit über 80 Jahren

Commitment to nature and quality for more than 80 years

L'engagement de produire des meubles naturels de qualité depuis plus de 80 ans



Naturholzmöbel sowie Loden sorgen für ein gesundes Raumklima

Natural wood furniture and loden ensure a healthy room climate

Les meubles en bois naturel ainsi que le loden assurent un climat ambiant particulièrement sain.



Innovativ mit Rücksicht auf die grüne und soziale Umwelt

Furniture made from natural wood creates a healthy atmosphere in your room

Innovatif en prenant soin de l'environnement social et naturel



Zertifiziert und ausgezeichnet

Certified and award-winning

Certifié et récompensé





AV154 | Eiche Altholz | Loden basaltgrau MB
Reclaimed oak wood | Chêne ancien



Inspirierend, echt & unverfälscht

Inspirational, real & genuine

Source d'inspiration réelle et authentique





AV121 Eiche Altholz
Reclaimed oak wood | Chêne ancien

Stein & Holz

Stone & Wood

Pierre et bois

Ein unwiderstehlicher Kontrast

An irresistible contrast

Un contraste irrésistible



Am Puls der Zeit – offen – flexibel – intelligent

State of the art- open- flexible-intelligent

Dans l'air du temps- ouvert- flexible- intelligent

AV298 | Eiche Altholz | Colorglas anthrazit
Reclaimed oak wood | Chêne ancien

Von den Alpen inspiriert

Inspired by the Alps

Inspiré des alpes

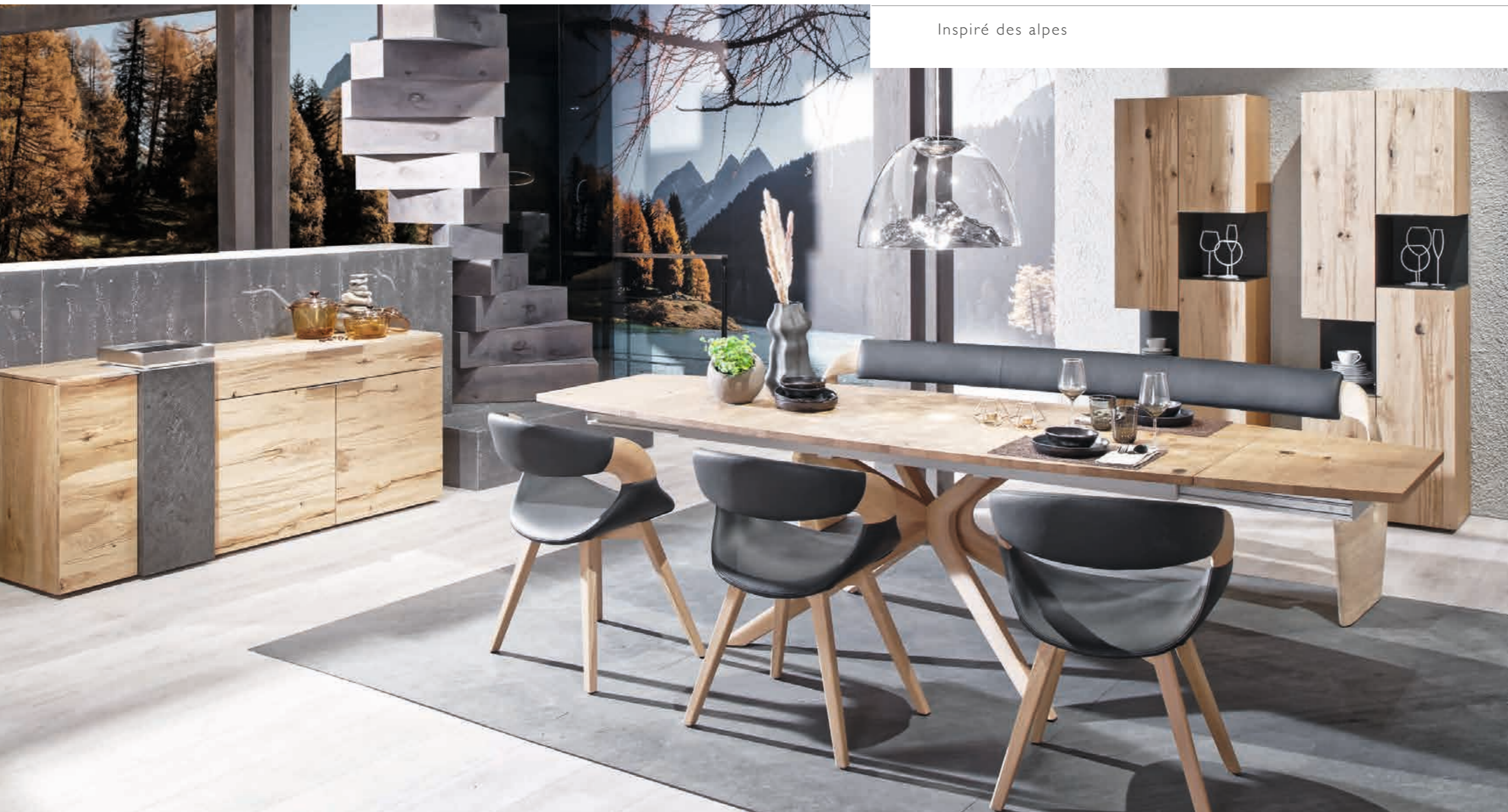

Optional mit Multifunktionsblech inkl. indirekter Beleuchtung und Aufladen von Handy und Tablet
Optionally with multifunctional tablet incl. indirect lighting and charging of mobile phone and tablet
Option avec tablette multifonctions, éclairage indirect et chargeur pour téléphone et tablette





Eiche Altholz | Leder schwarz LS
Reclaimed oak wood | Chêne ancien



Variante 1



Variante 2

Massivholz in unterschiedlicher Ausformung

Solid wood in perfect shape

Bois massif dans différents façonnages



Moderne Tischkultur mit dem richtigen Materialeinsatz

Modern table culture with the right use of materials

La culture de la table moderne avec le bon choix de matières



Tisch mit Keramikeinlage in Steinoptik mit archaischer Haptik,
für Abstellmöglichkeit heißer Töpfe

Table with ceramic inlay in stone look with archaic feel
for storage of hot pots

Table avec incrustation en céramique à l'aspect pierre et au toucher archaïque,
pour le stockage des pots chauds



Esszimmer Interior, das begeistert und Emotionen weckt.

A dining room interior that inspires and stimulates the emotions

Salle à manger Interior, pour ravir et éveiller les émotions





Polsterung Wahlweise glatt oder legere mit Falten
 Choice of upholstery smooth or casual with pleat
 Dossier avec rembourrage lisse ou plissé



B 60 cm
 T 58 cm
 H 82 cm



B 60 cm
 T 59 cm
 H 82 cm



B 58 cm
 T 62 cm
 H 82 cm



B 54 cm
 T 57 cm
 H 82 cm
 stapelbar



B 53 cm
 T 57 cm
 H 82 cm
 stapelbar



B 57 cm
 T 58 cm
 H 83 cm



B 55 cm
 T 57 cm
 H 81 cm
 stapelbar



B 54 cm
 T 61 cm
 H 86 cm
 stapelbar



B 50 cm
 T 61 cm
 H 88 cm



B 57 cm
 T 57 cm
 H 82 cm



B 51 cm
 T 49 cm
 H 93 cm und

B 52 cm
 T 51,5 cm
 H 103 cm



AV259

Wohnelemente mit vielen Möglichkeiten

Space for a number of possible uses

Éléments de vie aux nombreuses possibilités



Office integriert im Wohnzimmer
Office integrated in the living room
Bureau intégré au salon

Ambiente der Extraklasse

Ambience of the extra class

Ambiance de grande classe





Tablett mit indirektem Licht mittels Federkontakt sorgt für Stimmung.
Am Kubus wird die Powerbank aufgeladen.

Tray with indirect light creates atmosphere by an spring contact.
The power bank is charged at the cube.

La tablette avec éclairage indirect apporte de l'ambiance par simple contact.
La batterie est rechargée sur le meuble.



Neben der praktischen Ablage ist das Tablett auch für das Aufladen von Handy
oder Tablet mittels integrierter Powerbank geeignet.

In addition to the practical tray, the tablet is also suitable for charging a mobile phone
or tablet using an integrated powerbank.

En plus de l'aspect pratique de la tablette,
celle-ci permet de charger tablette ou téléphone.



Design für Erholung vom Alltag

Design for every-day relaxation

Un design pour se reposer au quotidien

Viele Details wie Hirnholz und bündige Glasabschlüsse
sowie ein Mikrosport machen dieses Element zu einem Highlight.

Many details such as end-grain wood and flush glass ends
and a microspot make this element a highlight.

De nombreux détails comme le bois de bout, les éléments
en verre affleurant ou le microspot font de cet élément un highlight.





100% DESIGN

100% design

Eiche Altholz ist pure Freude am natürlichen Material

Reclaimed oak wood offers the pure joy of natural materials

Le chêne ancien constitue le plaisir pur de la matière naturelle

Die Möbellinie V-Alpin erinnert an alte „Stadl'n“ und versetzt das Ambiente in einen alpinen Kontext: Spannend ist der Kontrast zwischen der puristischen Formensprache und dem besonderen Material. Jede Maserung ist individuell gewachsen, zudem bringt das Altholz durch unterschiedliche Einsatzbereiche seine eigene Geschichte mit.

The V-Alpin furniture range is reminiscent of old barns and provides an alpine ambience: The contrast between the purist design language and the special material is exciting. Each grain is grown individually and thanks to its different areas of use the old wood comes with its own history.

La ligne de meubles V-Alpin rappelle les anciens greniers et place l'atmosphère dans un contexte alpin: Le contraste entre le langage des formes épurées et la matière particulière est saisissant. Chaque veinure s'est développée individuellement. En outre, le bois ancien apporte sa propre histoire au travers des nombreux domaines d'utilisation.





AV175 | Eiche Altholz | Colorglas optiwhite
 Reclaimed oak wood | Chêne ancien



Wohnflair mit vielen Funktionen

Living flair with many functions

Charme intérieur aux nombreuses fonctions



Funktionen, die überzeugen

Captivating functions

Des fonctionnalités convaincantes



1 geschlossen
closed
fermé



2 aufklappen
open
ouvrir



3 verschieben
move
faire coulisser

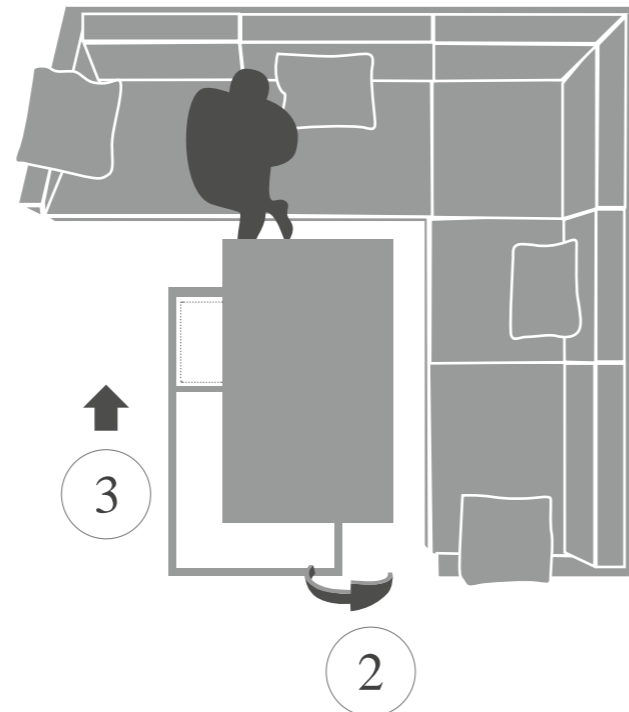
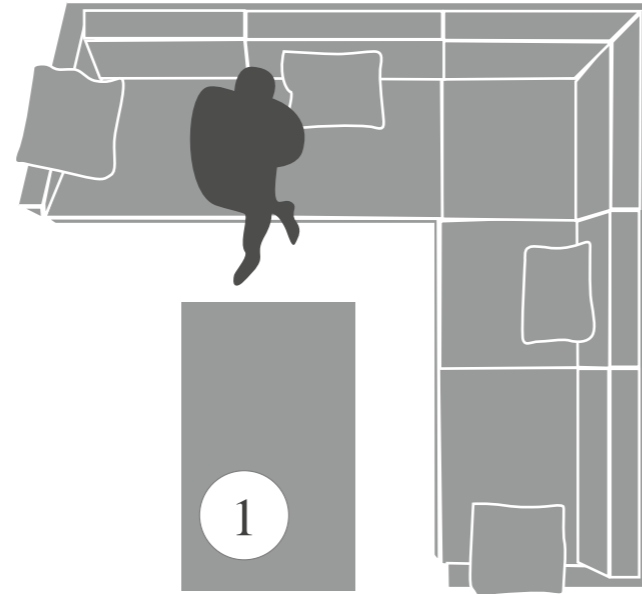

Langer Couchtisch auch mit Tür für Stauraum.
Long Coffee table also with door for storage space.
Table basse avec porte pour rangement.

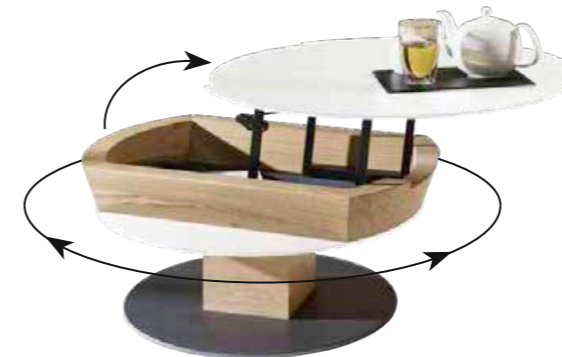

Couchtisch mit absolutem Mehrwert:
In die Höhe schwenken und drehen für jede Situation.
Coffee table with true added value.
It can be swivelled upwards and rotate for every situations.
Table basse d'une plus-value absolue.
Pivotante et relevable pour chaque situation.

Durch einen einfachen Handgriff lässt sich der Tisch in der Höhe verstellen und eignet sich auch ideal zum Essen.

Just a simple movement alters the height of the table and makes it ideal to eat at.

Grâce à une poignée simple à utiliser, la table est réglable en hauteur et est également idéale pour prendre un repas.





Eiche Altholz
Reclaimed oak wood | Chêne ancien



Couhtisch mit Hirnholzkubus
mit leicht wirkendem Glasgestell

Coffee table with end-grain wood cube
with light-looking glass frame

Table basse avec élément en bois de bout et
un élément en verre qui apporte en légèreté



Kompakt und praktisch

Compact and practical

Compact et pratique



Für jeden Gebrauch das richtige Möbel

The right furniture to meet every need

Le meuble idéal pour chaque utilisation



Eiche Altholz – ein Holz mit Geschichte

Old oak wood - wood with a history

Chêne ancien – un bois chargé d'histoire

Dieses Holz erinnert an alte Bauernhäuser und „Stadl'n“. Die entstandenen Gebrauchsspuren erhielt dieses Holz durch die Einflüsse von Sonne, Wind und Wetter.

This wood being reminiscent of old farmhouses and barns. This results in a wood marked by sun, wind and weather.

Ce bois évoque les vieilles fermes et greniers. Les traces d'utilisation sur la surface sont le résultat de l'action du soleil, du vent et des intempéries.



AV224 | Eiche Altholz | Glas anthrazit
Reclaimed oak wood | Chêne ancien

Mit allen Sinnen wohnen

Living with all your senses.

Vivre en harmonie avec vos sens.



AV 518 | Eiche Altholz | Glas optiwhite
Reclaimed oak wood | Chêne ancien

Modernität
& Tradition

Modernity & tradition

Modernité & tradition

Eiche Altholz | Leder schwarz LS
Reclaimed oak wood | Chêne ancien

Massivholz in vollendeter Ausformung

Solid wood in perfect shape

Le bois massif dans sa forme parfaite



Mit dem attraktiven Einhand-Beschlag kann der Tisch wahlweise auf jeder Seite um 50 cm verlängert werden. Das Tischgestell bleibt dabei fix auf Standposition.
Tischplatte abgerundet oder gerade.

Each side of the table can be extended up to 50 cm using the attractive single handle fitting. The table frame remains fixed in its standing position.
Tabletop rounded or straight.

Le mécanisme à une main permet de rallonger au choix de chaque côté la table de 50 cm. Le bâti de table reste fixe dans sa position.
Plateau de table arrondi ou droit.

Eiche Altholz | Leder schwarz LS
Reclaimed oak wood | Chêne ancien



Die puristischen Möbel von V-Alpin in Eiche Altholz sorgen für außergewöhnliches Wohnflair – sowohl für den urbanen als auch für den ländlichen Lebensraum.

Purist furniture by V-Alpin made of old oak wood provides exceptional living flair - both in urban and rural settings.

Les meubles aux lignes épurées V-Alpin en chêne ancien assurent un charme intérieur exceptionnel – aussi bien dans un espace de vie urbain que campagnard.



AV126 | Eiche Altholz | Colorglas optiwhite
 Reclaimed oak wood | Chêne ancien

Inspiration für jeden Raum

Inspiration for every room

Une inspiration pour chaque pièce



Eiche Altholz | Colorglas anthrazit | Akustikstoff
 Reclaimed oak wood | Chêne ancien



Holz & Glas – ein spannender Materialmix
 Wood & glass – An exciting mix of materials
 Bois et verre – une alliance de matériaux fascinante



AV140 | Eiche Altholz | Colorglas anthrazit
 Reclaimed oak wood | Chêne ancien

AV147 | Eiche Altholz
 Reclaimed oak wood | Chêne ancien



Inspirierend, echt & unverfälscht

Inspirational, real & genuine

Source d'inspiration réelle & authentique

Dielen



Folder auf unserer Homepage anfordern.
Wir senden Ihnen diese gerne kostenlos zu.





In harmony with the natural cycle

As a responsible manufacturer of furniture made of natural wood, the Voglauer brand stands for sustainable use of nature's resources. We therefore use only timber from sustainable forestry for our manufacturing processes, so Voglauer produces in total harmony with natural cycles. Every tree that reaches your home as furniture is guaranteed to regenerate.

Le cycle de la nature

En tant que fabricant de meubles en bois responsable, Voglauer a toujours mis un point d'honneur à n'utiliser que des matériaux naturels. C'est pour cette raison que nous n'utilisons que du bois issu de sylvicultures durables. La production Voglauer respecte la nature.

Ainsi, chaque arbre ayant servi à la fabrication de votre meuble peut continuer à vivre.



Natur riechen
Qualität spüren

Sniff nature, sense real quality
Vivre au naturel

Im Kreislauf mit der Natur

Als verantwortungsvoller Produzent von Naturholzmöbeln steht die Marke Voglauer seit jeher für einen nachhaltigen Umgang mit den Ressourcen der Natur. Daher werden im Fertigungsprozess ausschließlich Hölzer aus nachhaltiger Forstwirtschaft verwendet, womit Voglauer voll im Kreislauf mit der Natur produziert.

Jeder verwendete Baum, den man sich als Möbel ins Haus holt, wächst mit Garantie wieder nach.

Die Möbel von V-Alpin bestehen nicht nur durch formvollendetes Design, sondern auch durch höchste Qualität und Natürlichkeit.

Damit die natürlichen Oberflächen dieser Möbel besonders gut zum Ausdruck kommen, werden sie mit dem einzigartigen Voglauer Oberflächensortiment behandelt. Aus nachwachsenden Rohstoffen hergestellt, schafft diese Hartöl-Wachskombination auf Basis pflanzlicher Öle die perfekten Voraussetzungen für gesundes Wohnen.



Voglauer Qualitätssiegel

Voglauer seal of quality | La qualité Voglauer

Achten Sie auf das Voglauer Label und den Brennstempel – das Qualitätssiegel für originale Voglauer Möbel aus dem Salzburger Land. Hier kaufen Sie höchste Qualität und Natürlichkeit!

Watch for the Voglauer labelling and branding iron – the hallmark of quality for original Voglauer furniture of the Salzburger Land. Here you will purchase premium quality and naturalness!



Le label et la marque Voglauer – la qualité par excellence pour des meubles originaux provenant de Salzburger Land. Chez Voglauer, vous ne trouverez que des meubles de qualité et naturels!

Sorgsam ausgesuchte Hölzer |

Carefully selected wood | Des bois sélectionnés avec soin



Eiche Altholz

Akzent Front: Colorglas

Accent front: satin glass | L'accent sur l'avant: verre satiné



A | anthrazit



O | optiwhite

Bezugstoff fabric | tissu d'ameublement

* eingeschränkt verfügbar, siehe Typenliste (Webseite)

Loden Loden | Loden

Loden besteht aus 100 % reiner Merino-Schurwolle und ist daher ein hochwertiges Naturprodukt. Der Rohstoff Wolle ist langlebig, luftdurchlässig, hautfreundlich, elastisch, isolierend und durch seinen Fettgehalt schmutzabweisend.

Loden consists of 100% pure Merino Wool, and is therefore a high-quality natural product. Raw wool is durable, breathable, skin-friendly, elastic, insulating and dirt resistant due to its fat content.

Le loden est composé à 100 % de pure laine vierge mérinos et est de ce fait un produit naturelle de grande valeur. La matière première laine présente une durée de vie élevée, est perméable à l'air, agréable sur la peau, élastique, isolante et repousse la saleté grâce à sa teneur en graisse.



MG | grauweiß



MB | basaltgrau



MT | tundra Braun

Leder Leather | Cuir

Kräftiges, weiches Rindleder mit markanter Oberflächenstruktur (Millkorn) und hochwertigen Farbpigmenten.

Strong, soft cowhide leather with distinctive surface structure (mill corn) and high-quality colour pigments.

Un cuir de bœuf puissant et souple à la structure de surface remarquable (maïs semoulier) et aux pigments colorés haut de gamme.

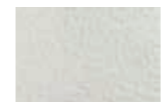

LR | reinweiß

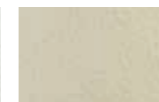

LW | sahne



LY | ziegelrot



LX | burgundy

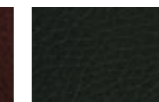

LZ | army green



LV | cognac



LU | caffè



LT | testa di moro



LK | kiesel

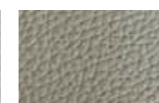

LO | coco



LM | stone



LP | cenere

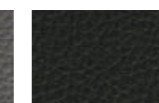

LN | anthrazit

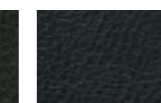

LL | oceano



LS | schwarz



LA | azurblau

Vintage Vintage | Vintage



VQ | quarz

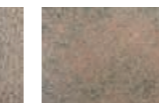

VB | bronze



VT | terra



VM | moor

Textilleider in used look aus 100% Mikrofaser (PES)

Faux leather in used look made from 100% microfiber (PES)

Cuir synthétique effet usé, 100% microfibras (PES)

Curl Curl | Curl (Bezugsstoff)



CN | natur



CM | melange

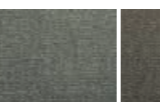

CW | warm grey

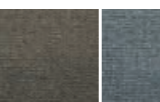

CT | timber

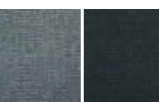

CS | steele

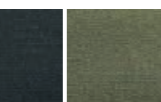

CB | black



CO | olive



CD | dark blue



CR | royal red

Textil in Naturhaptik mit höchster schmutzabweisender Eigenschaft (Patentierter Q2 Faser, 74/26 PAN/PES)

Textile in natural haptics with highest dirt-repellent property (patented Q2 fiber, 74/26 PAN/PES)

Textile au touché naturel avec propriétés hautement anti-poussière. (breveté Q2 fibre, 74/26 PAN/PES)

Chalet Chalet | Chalet (Bezugsstoff)



CP | perl

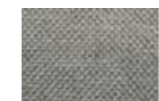

CK | kiesel



CU | umbragrau



CV | vidalschwarz

Textil in Naturhaptik mit höchster schmutzabweisender Eigenschaft (Patentierter Q2 Faser, 74/26 PAN/PES)

Textile in natural haptics with highest dirt-repellent property (patented Q2 fiber, 74/26 PAN/PES)

Textile au touché naturel avec propriétés hautement anti-poussière. (breveté Q2 fibre, 74/26 PAN/PES)



VOGLAUER

Farbabbildungen dienen nicht als Farbmuster!

Sideboards

Alle Elemente auch spiegelbildlich lieferbar

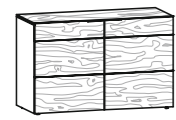

B/T/H 128/51,6/82 cm

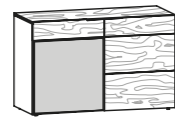

B/T/H 128/51,6/82 cm

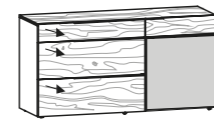

B/T/H 160/51,6/82 cm

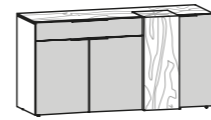

B/T/H 160/54,9/82 cm

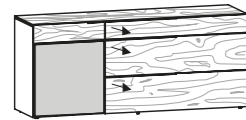

B/T/H 192/51,6/82 cm

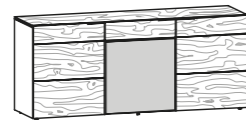

B/T/H 192/51,6/82 cm

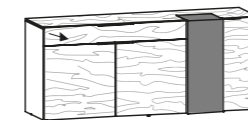

B/T/H 192/54,9/82 cm

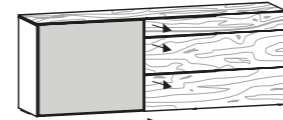

B/T/H 224/51,6/82 cm

Highboards

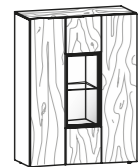

B/T/H 96/42,3/130 cm

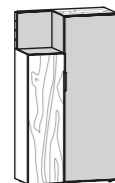

B/T/H 80/37,3/146 cm

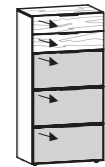

B/T/H 64/42,3/130 cm

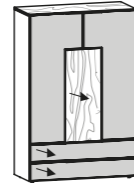

B/T/H 96/42,3/146,2 cm

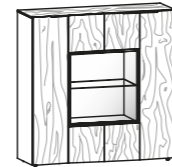

B/T/H 128/42,3/130 cm

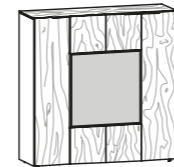

B/T/H 128/42,3/130 cm

Vitrinen

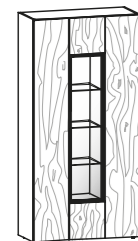

B/T/H 96/42,3/194 cm



B/T/H 64/42,3/194 cm

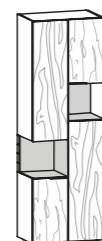

B/T/H 64/42,3/194 cm

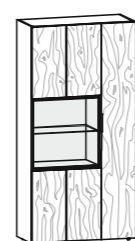

B/T/H 96/42,3/194 cm

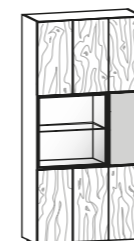

B/T/H 96/42,3/194 cm

Lowboards



B/T/H 128/55/34 cm

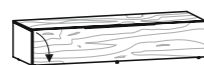

B/T/H 160/55/34 cm



B/T/H 192/55/34 cm

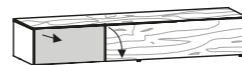

B/T/H 192/55/34 cm

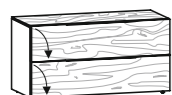

B/T/H 128/55/66 cm

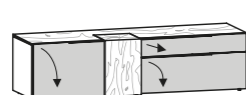

B/T/H 160/58,3/50 cm

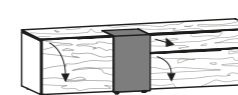

B/T/H 192/58,3/50 cm

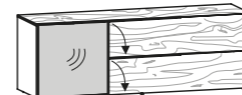

B/T/H 192/55/66 cm

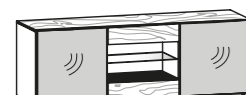

B/T/H 192/55/66 cm

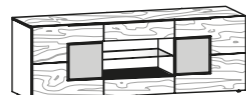

B/T/H 192/55/66 cm

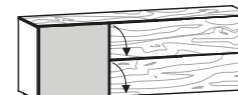

B/T/H 192/55/66 cm

Mediaelemente

Alle Elemente auch spiegelbildlich lieferbar

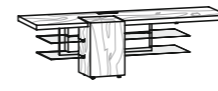

B/T/H 176/56,7/50 cm

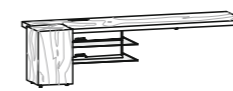

B/T/H 192/56,7/50 cm

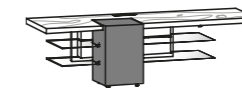

B/T/H 176/56,7/50 cm

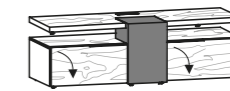

B/T/H 160/58,3/50 cm

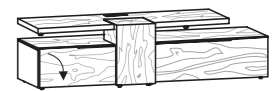

B/T/H 192/58,3/50 cm

Wandpaneele

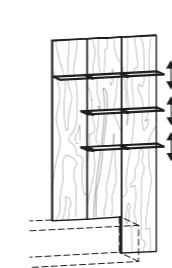

B/T/H 95,6/28/191,6 cm

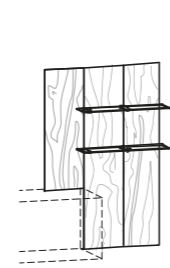

B/T/H 95,6/28/143,6 cm

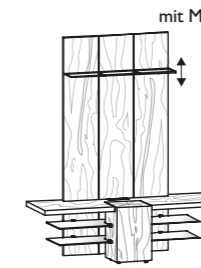

mit Mediaelement

B/T/H 160/56,7/193,8 cm

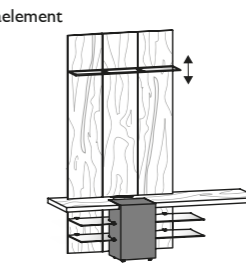

mit Anbauelement oder Anbauvitrine

B/T/H 176/56,7/193,8 cm

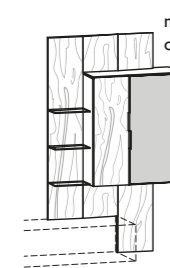

B/T/H 111,8/37,3/193,8 cm

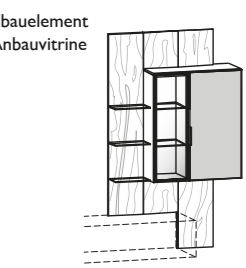

B/T/H 111,8/37,3/193,8 cm

Hängeelemente



B/T/H 64/37,3/128 cm



B/T/H 32/37,3/128 cm



B/T/H 32/37,3/128 cm



B/T/H 32/37,3/160 cm



B/T/H 32/37,3/160 cm



B/T/H 64/37,3/64 cm



B/T/H 64/37,3/64 cm

Hänge- Klappenelemente



B/T/H 128/37,3/32 cm



B/T/H 192/37,3/32 cm

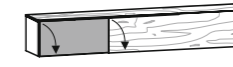

B/T/H 192/37,3/32 cm

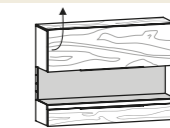

B/T/H 128/37,3/93,4 cm

Wandborde

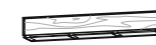

Wandbord mit Glasablage

B/T/H 128 oder 192/23/18,2 cm



Wandsteckbord

B/T/H 128 oder 176/192/24/3,9 cm



B/T/H 95,6/28/31,6 cm



B/T/H 95,6/28/63,6 cm



B/T/H 95,6/28/95,6 cm



B/T/H 95,6/28/127,6 cm

Couchtische

Platte um ca 2 l cm tum Anheben und Verschieben

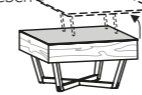

B/T/H 80/80/43,5-64,5 cm

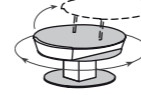

B/T/H 80/80/38 cm

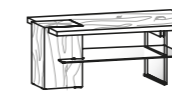

B/T/H 120/75/50 cm

Wahlweise mit 1,2 oder ohne Lade möglich

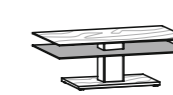

B/T/H 75/120/46 cm

höhenverstellbar 38,3 bis 74,3 cm



B/T/H 90/90/38,3-74,3 cm

Beistelltische



B/T/H 40/40/48 cm



B/T/H 40/40/56 cm

Kuben



B/T/H 48/48/10 cm



B/T/H 34,4/34,4/35 cm

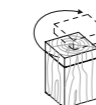

B/T/H 34,4/34,4/52 cm



B/T/H 34,4/34,4/73 cm

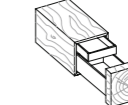

B/T/H 34,4/80/34,9 cm

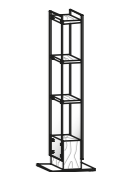

B/T/H 38/38/129,5 cm



Bänke

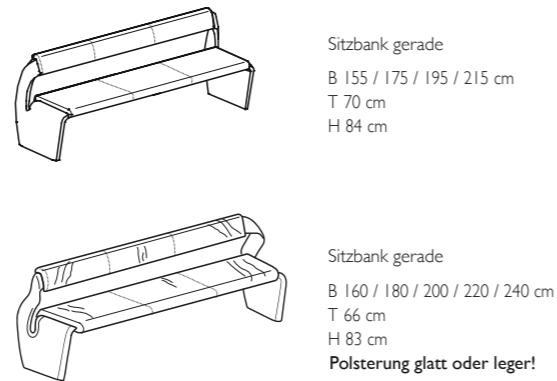
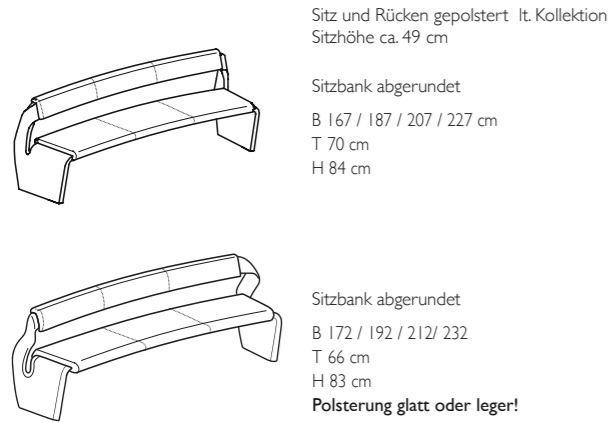

Tische

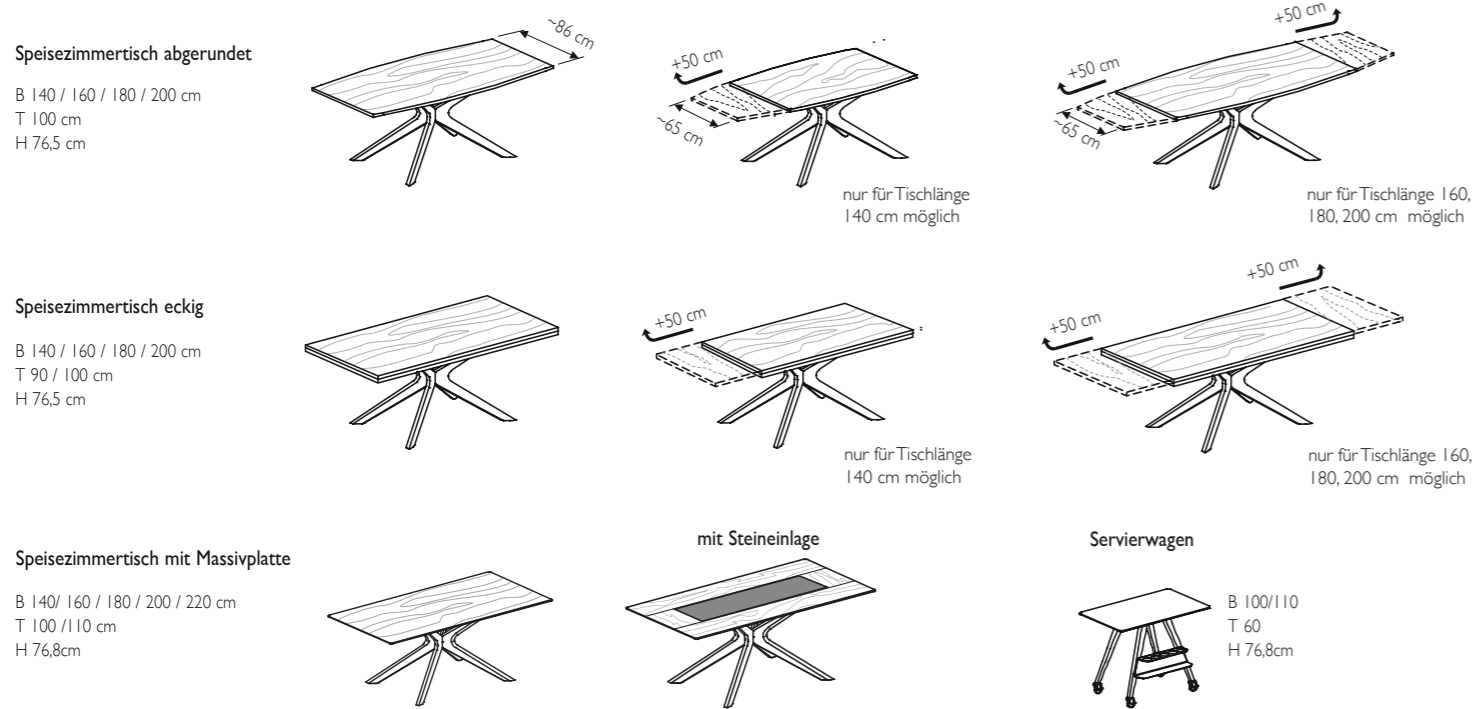

Stühle



Die komplette Typenliste – alle Varianten und Typen – kann auf unserer Homepage heruntergeladen werden.
The complete type list can be downloaded from our homepage.
Il y a la possibilité de télécharger la liste de modèle de notre page d'accueil.

Wohnwandkombinationen

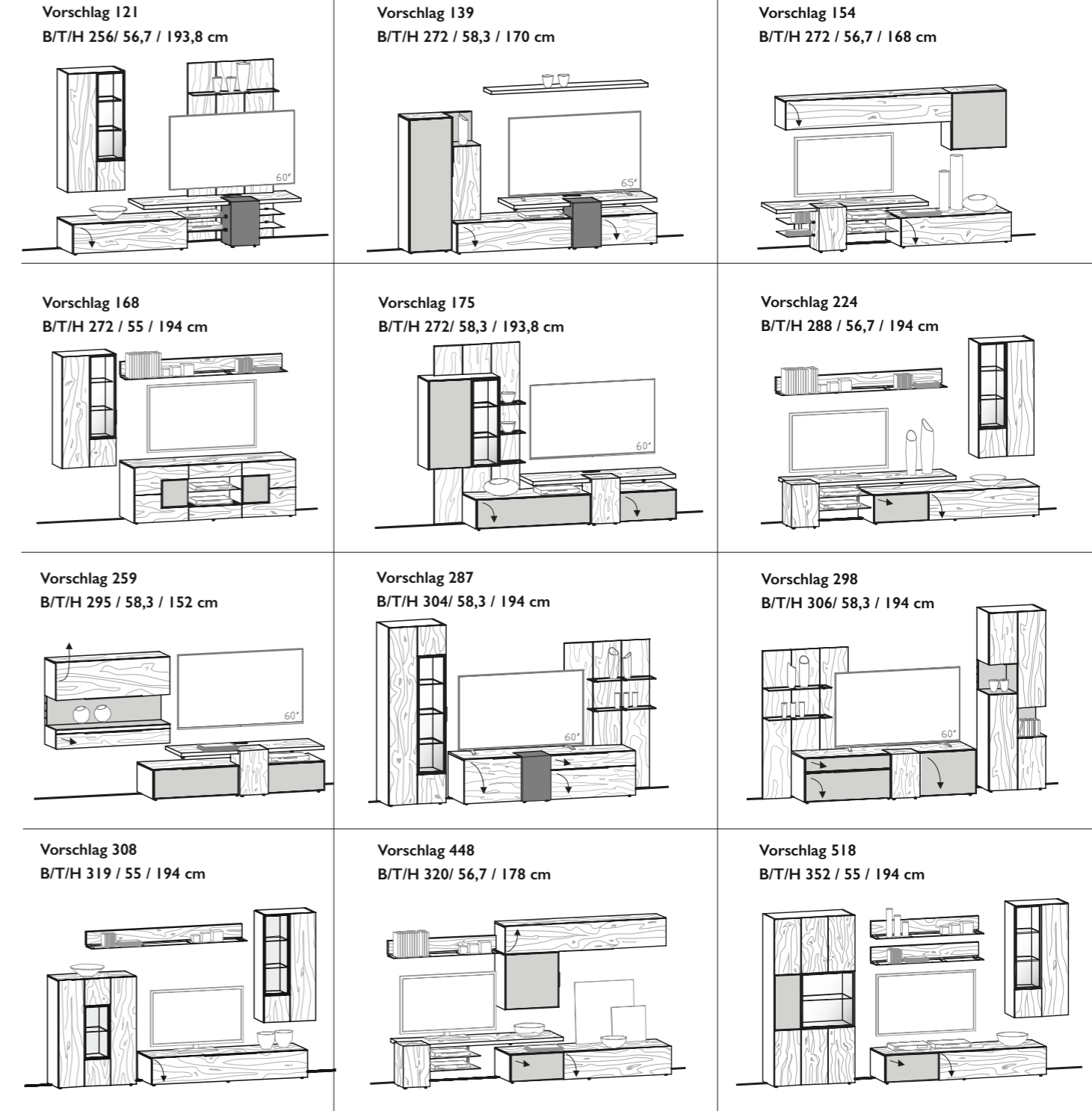

Alle Wohnwandvorschläge auch seitenverkehrt möglich!

Weitere Informationen über Typen und Varianten erhalten Sie bei unserem Möbelhandelspartner in Ihrer Nähe!

Zu finden im Internet auf www.voglauer.com unter der Rubrik: „Händler“.

You'll be informed other information about our furniture at our trade-partner near you!

You'll find them on the Internet at www.voglauer.com under the heading: "Traders".

Pour plus d'information concernant nos meubles, n'hésitez pas à aller voir notre partenaire le plus proche de chez vous !

Vous trouverez la liste de nos partenaires sur le site www.voglauer.com, dans la rubrique « Nos magasins ».

ALLE VOGLAUER MÖBELLINIEN

WOHNEN / SPEISEN



V-Alpin
NEUHEIT 2021

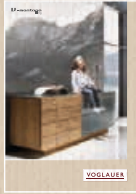

V-Montana

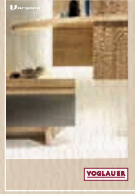

V-Organo living

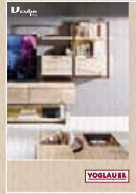

V-Cube living

SCHLAFEN



V-Alpin sleeping
NEUHEIT 2021

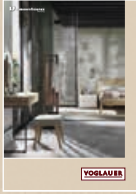

V-Montana sleeping

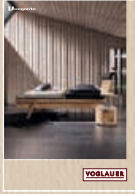

V-Vaganto

DIELEN



V-Alpin
NEUHEIT 2021



V-Montana



V-Organo coming

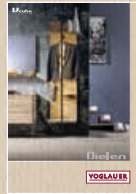

V-Cube coming

BAD



V-Alpin
NEUHEIT 2021



V-Montana



V-Quell



Ihr Voglauer Einrichtungspartner:

Fordern Sie die gewünschten Folder telefonisch oder auf unserer Homepage an. Wir senden Ihnen diese gerne kostenlos zu.

Sie wollen mehr über unser Unternehmen oder unsere Produktlinien erfahren? Dann besuchen Sie uns im Internet unter www.voglauer.com



Besuchen Sie uns auf Facebook und werden Sie unser Freund! Hier werden Sie regelmäßig informiert über aktuelle Entwicklungen und News rund um VOGLAUER.

@voglauermoebel

Voglauer Gschwandtner & Zwilling GmbH
A-5441 Abtenau / Salzburger Land | Tel. +43 6243 2700-0 | Fax DW-210
office@voglauer.com | www.voglauer.com